

TRAINING SYSTEMS & MODELS

Training panels

PAGES 152 - 156



Fieldbus

PAGES 157 - 159

Safety training

PAGES 160 - 161



Training systems

PAGES 162 - 171

PLC

PAGES 172 - 175



Programming

PAGES 176 - 179

Regulation

PAGES 180 - 190



Energy

PAGES 191 - 193

Motor system

PAGES 194 - 196

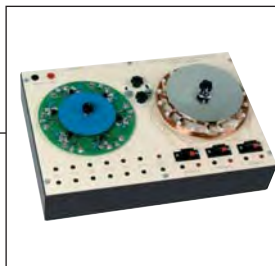

Circuit Lab

PAGES 197 - 203

Test units

PAGES 204 - 206



Sensors

PAGES 207 - 209

TRAINING PANELS

Home automation panel with touchscreen and radio components



Coupling a receiver + transmitter pair through the protection window by pressing a contact.

Panel delivered wired, programmed, with instructions of each components, diagrams and practical works

ref. DOMOPLUS



EDUCATIONAL OBJECTIVES

- Understanding of the housing automation made for the housing renovation
- Understanding of a real and complete solution for a flat
- Studying the wiring and settings of communicating components
- Studying the programming and the DELTA DORE solution

TEACHING RESOURCES STUDENT & TEACHER

Proposed Practical Works

- Renovation of different circuits (lightings, thermal circuit ...)
- Programming according different imposed scenarios

Features of the basement

- Base on large wheels.
- Dim L x l x H : 1500 x 750 x 1980mm.
- Melamine surface : 1200 x 1700mm.
- Weight : 128kg.

Controlled by switch, remote telephone or colour touchscreen, these control lighting, openings (blinds, gates), heating, sprinklers, etc. To familiarize students with the cabling, each electrical component is connected using a terminal strip to its control or receiver module. A removable translucent plate covers the connections and protects the electrical contacts.



Components located on the panel:

- 1 modular panel equipped with 5 circuit-breakers and one differential 30mA
- 5 lighting circuits "living room" "kitchen" "garage" "garden".
- 3 motor opening circuits:
 - 1 motor roller shutter - 1 garage door and 1 gate (simulated by 2 boxes with indicator lights)
- 1 heater 500W + 1 radio receiver.
- 1 sprinkler pump (simulated by indicator light) + 1 radio receiver.
- 1 remote control by telephone controlling 2 lighting sets or the roller shutter.
- **All these components are associated with radio transmitters and or receivers**
- 1 touchscreen 480x272 pixels capable of managing the radio components of the dwelling with built-in tutorial for component configuration.

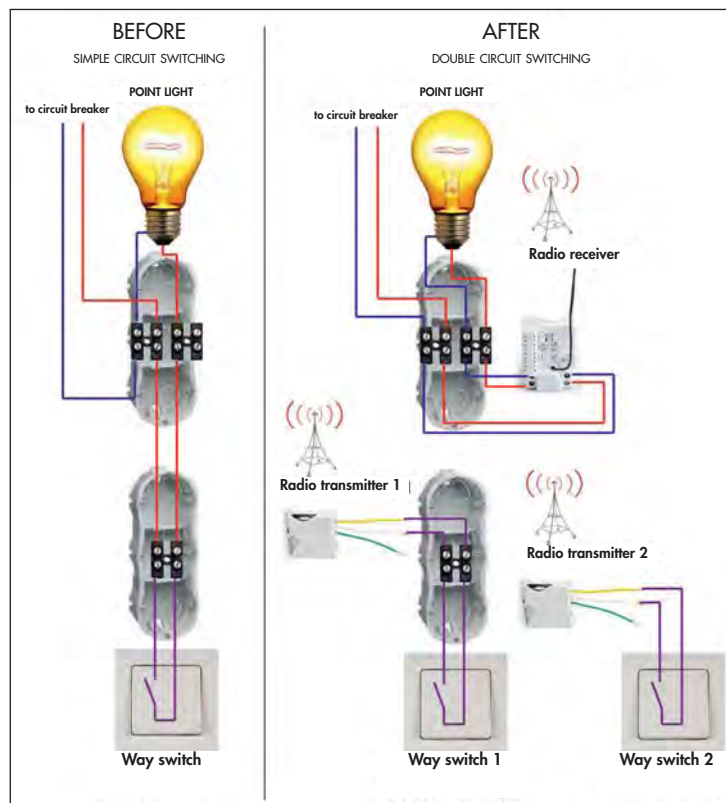

IMPORTANT:

The panel is fitted with a stand-alone telephone line. Commands sent from the telephone set that is supplied with the system are not routed via the school's telephone network or via the public telephone network.

Study system for the KNX bus



Features

- Power supply 230VAC by 5-metre mains cord
- Dimensions of the frame: 950 x 50 x 1620mm
- Dimensions of each module: 250 x 165 mm
- Total weight: 50 kg

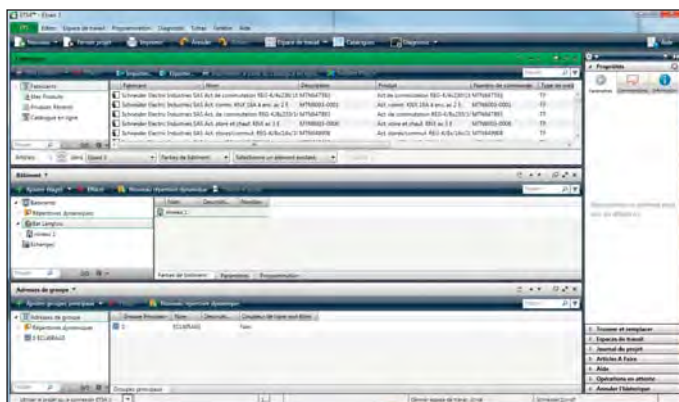

ETS Lite programming software

Additional KNX
modules
See Page 54



EDUCATIONAL OBJECTIVES

- Studying KNX communication media
- Studying the principle of a home control installation with KNX devices
- Configuration of KNX devices
- Creating the wiring of KNX devices
- Creating home control scenarios

NEW

TEACHING RESOURCES STUDENT & TEACHER

Practical works

- Creation of the complete wiring diagram
- Study the creation of KNX wiring and programming for the functions of lighting control, shutter and opening control using pushbuttons
- Creation of home control scenarios like using a single key to switch off the lights, lower the blinds and open the garage door and the gate
- Combine several different brands makes with the same KNX standard

ref. DOMO-KNX

The KNX bus offers a standard of compatibility and interoperability that is unique and global in the home control sector.

With "KNX PARTNER" certified manufacture, the DOMO-KNX model enables the study and putting into service of multibrand KNX products, SCHNEIDER® and HAGER® (other on request). The KNX devices are prepared in plastic housings with the front engraved and equipped with Ø4mm terminals. The wiring of the Bus and the power are then created using safety leads. We selected the most commonly used KNX modules in the "intelligent home" domain. These modules are easy to install on the aluminium wheeled frame. The KNX devices are configured using the ETS Lite tool (20 participants max.) supplied with the model.

Comprises

- 1 Aluminium wheeled frame taking 18 modules
- 1 Power supply console 230VAC on Ø4mm terminals protection by RC circuit-breaker 30mA + emergency stop + 2 2P+E outlets with indicator light
- 1 Rack for leads - 20 fingers
- 1 30V power supply module for the bus
- 1 USB interface module for programming from a PC
- 2 4-key pushbutton modules with indicator lights (1 per brand)
- 1 2-key pushbutton module with indicator lights
- 1 universal pushbutton interface module
- 1 Presence detector module
- 1 4-output switch actuator module
- 1 2-output switch actuator module
- 1 2-output control actuator module
- 1 1-output control actuator module
- 1 2-output roller blind actuator module
- 1 Module with printing and signalling for two roller blinds
- 1 Module with printing and signalling for opening / closing gate and garage
- 4 Modules for bulkhead lights 60W - 230VAC

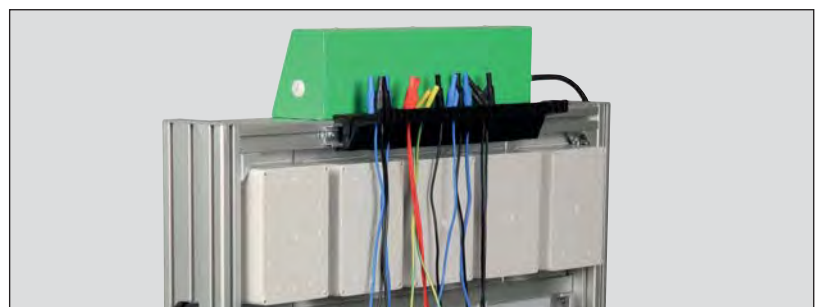

Training panels - simple or communicating version

ACCESS CONTROL SYSTEM (BY SWIPE CARDS & ENTRY SYSTEM)



EQUIPMENT

- 1 educational, reinforced electrical cabinet and modular equipment. 230V AC power supply. Protected by circuit breakers, including one 30mA.
 - 1 access control module, 6 swipe cards and 1 entry system.
 - 1 PLC **Schneider®**
- Supplied with programming software and communicating software **Vijeo Designer®**.

ref. GES-2-COM

EDUCATIONAL OBJECTIVES

- Understanding and setting of an access control system by swipe cards & entry system
- Programming and setting of the Schneider® PLC (for the COM version)
- Understanding and use of the supervision on PC (for the COM version)
- Understanding of an IP network (for the COM version)

USER'S MANUAL + PRACTICAL WORKS

ENTRY ACCESS & VIDEO ACCESS CONTROL SYSTEM



EQUIPMENT

- 1 educational, reinforced electrical cabinet and modular equipment. 230V AC power supply. Protected by circuit breakers, including one 30mA.
 - 1 door, opening onto the "street", with electric door opener
 - 1 "street" video unit comprising: a camera / a loudspeaker / a 4-button caller keypad (one for each area)
 - 1 "building" videophone with a screen that is linked to the camera
 - 3 "building" entry phones
The videophone and entry phones have a button which controls the electric door opener
 - 1 4-channel distributor for interconnecting the videophone and entry phone
 - 1 PLC **Schneider®**
- Supplied with programming software and communicating software **Vijeo Designer®**.

ref. GES-5-COM

EDUCATIONAL OBJECTIVES

- Understanding and setting of an access control system by video and intercom
- Programming and setting of the Schneider® PLC (for the COM version)
- Understanding and use of the supervision on PC (for the COM version)
- Understanding of an IP network (for the COM version)

USER'S MANUAL + PRACTICAL WORKS

FIRE DOOR CONTROL SYSTEM



EQUIPMENT

- 2 resettable manual triggers with diaphragms
 - 2 optical smoke detectors They can be activated using an aerosol that is supplied with the panel
 - 1 independent initiating detector fitted with a maintenance-free battery (3 hours autonomy)
 - with reset push-button - with operating test push-button
 - 1 door with electric bolt
 - 1 PLC **Schneider®**
- Supplied with programming software and communicating software **Vijeo Designer®**.

ref. GES-6-COM

EDUCATIONAL OBJECTIVES

- Understanding and settings of a fire door control system.
- Programming and setting of the Schneider® PLC (for the COM version)
- Understanding and use of the supervision on PC (for the COM version)
- Understanding of an IP network (for the COM version)

USER'S MANUAL + PRACTICAL WORKS

WIRELESS ANTI-INTRUSION UNIT



EQUIPMENT

- 1 radio unit fitted with a siren which can be disabled.
- 1 radio keypad for receiving information and remote control, with LCD display
- 2 infrared sensor. 12m range
- 2 radio remote controller 4 buttons. Range 100 to 300m.
- 2 break contacts for protecting access points (doors and windows, etc.)
- 1 optical smoke detector with its own aerosol.
- 1 telephone interface
- 1 telephone
- 1 telephone transmitter carries out all the alarm transmission and reception functions.

The panel is fitted with a stand-alone telephone line. Doesn't require the public telephone network.

ref. GES-92

EDUCATIONAL OBJECTIVES

- Understanding and settings a wireless anti-intrusion unit
- Programming of the different components of an anti-intrusion unit like the main unit, the sensors, the keyboard, the ringing alarm, the autocom (PBX), the transmitter, the remote controllers.

USER'S MANUAL + PRACTICAL WORKS

INTRUDER ALARM CONTROL SYSTEM



EQUIPMENT

- 1 stand-alone alarm unit (powered by mains and battery)
- 1 power supply for the sensors
- 2 infrared detectors
- 1 keypad for code entry (4 numbers)
- 1 siren
- 1 flashing light
- 1 magnetic door-opening detector fitted on the window
- 1 PLC **Schneider®**

Supplied with programming software and communicating software **Vijeo Designer®**.

ref. GES-3-COM

EDUCATIONAL OBJECTIVES

- Understanding and settings an anti-intrusion unit
- Programming and setting of the **Schneider®** PLC (for the COM version)
- Understanding and use of the supervision on PC (for the COM version)
- Understanding of an IP network (for the COM version)

USER'S MANUAL + PRACTICAL WORKS

LIGHT CONTROL IN A BUILDING



Side with push buttons and spotlights



Side with electrical cabinet presence and brightness sensors

EQUIPMENT

- 1 educational, reinforced electrical cabinet and modular equipment.
- 1 push button operated remote dimmer switch to control the spotlight brightness
- 1 push button operated remote dimmer switch to control brightness and a presence sensor
- 1 dusk-to dawn switch
- 1 push-button operated timer with switch-off warning
- 1 presence detector with dusk-to-dawn cell to control a fluorescent tube
- 1 daily timer switch with infrared presence detector to control an incandescent lamp
- 1 PLC **Schneider®**

Supplied with programming software and communicating software **Vijeo Designer®**.

ref. GES-11-COM

EDUCATIONAL OBJECTIVES

- Understanding and settings of a light control system with various sensors.
- Programming and setting of the **Schneider®** PLC (for the COM version)
- Understanding and use of the supervision on PC (for the COM version)
- Understanding of an IP network (for the COM version)

USER'S MANUAL + PRACTICAL WORKS

Security lighting control system



Front view



Rear view

CONFIGURATION SOFTWARE for the addressable self-contained emergency lighting unit supplied with GES-41 and GES41-COM

User-friendly, only a few minutes are required to start using this software. Each self-contained emergency lighting unit has its own address. Configuration information and faults detected on the self-contained emergency lighting units are permanently stored in a database. PC connection using a RJ45 connector

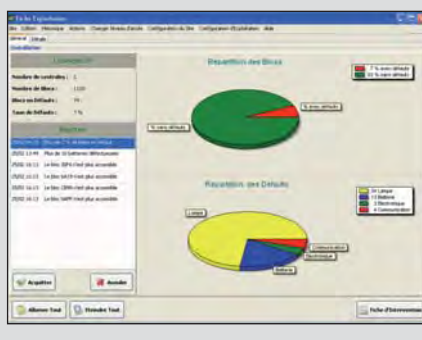

ref. GES-41-COM

ref. GES-41 no communicating, without PLC



Profile view

Base on wheels

- Dim L x l x H : 750 x 670 x 1950mm. 130kg.
- White melamine panel. Dimensions: 1000 x 750mm.

Features of the PLC supplied with GES-41-COM

- 9 24VDC inputs / 7 binary outputs
- Software supplied with ladder language programme
- Programming: sequential function chart or ladder language
- Fully functioning program: Supplied
- Ethernet connection to the IP computer network

Supplied with the supervision software **jejo designer®**

EDUCATIONAL OBJECTIVES

- Understanding and settings of a security lighting control system with autonomous batteries or a main power supply.
- Making of the wiring of components and security lighting units
- Understanding of the security lighting units addressing
- Use of the setting software URA vision
- Programming and setting of the Schneider® PLC (for the COM version)
- Understanding and use of the supervision on PC (for the COM version)
- Understanding of an IP network (for the COM version)

USER'S MANUAL + PRACTICAL WORKS

Practical works

- Settings of the addressable security lighting units with the use of URA vision software
- Realization of complete wiring
- Measurement of the voltage and current on the main power supply
- Test of the different functionalities
- Programming and setting of the Schneider PLC (for the COM version)
- Understanding and use of the supervision on PC (for the COM version)
- Understanding of an IP network (for the COM version)

Monitoring software supplied

Allows you to:

- acquisition and display of PLC variables
- monitoring and control of the process
- you to create your own monitoring

Displays:

- battery-operated
- the presence of a voltage on the lighting unit terminals

Controls:

- the activation of the anti-panic unit
- the activation of the security lighting units



TECHNICAL FEATURES AND EQUIPMENT

- 1 educational, reinforced electrical cabinet and modular equipment. 230V AC power supply. Protected by circuit breakers, including one 30mA.
- The unit is supplied fully wired, in working order, with a wiring diagram, operating principle and detailed instructions for each component.

Front panel: Units power supply from a central source

- 2 LED 'EVACUATION' lighting units
- 2 LED 'MOOD' lighting units
- 1 BTM modular remote control
- 1 switching unit controlling the "MOOD" lighting units.
- 1 central source (LSC), equipped with a sealed battery, 48V/160W voltage, 4 fuse outputs, digital display of the operating voltage, drain current, indicator lights for the mains power on, battery operations, battery charging and faults.
- 1 forced operation switch for the 'MOOD' lighting.
- 1 spotlight connected to the mains, showing its presence.

Back panel: Power supply for the stand-alone units.

- 1 addressable, LED 'MOOD' and self-contained emergency lighting unit (BAES), with information transferred to the PC.
- 1 addressable, LED 'EVACUATION' and self-contained emergency lighting unit (BAES), with information transferred to the PC.
- 1 addressable, 'BI-FUNCTIONAL' LED and self-contained emergency lighting unit (BAES), with information transferred to the PC.
- 1 modular BTI URAVISION interface for the ETHERNET connection between the self-contained emergency lighting unit network and the computer.
- 1 manual unit shutdown control
- 1 spotlight connected to the mains, showing its presence.

Study model for the PROFINET system with supervision – SIEMENS®

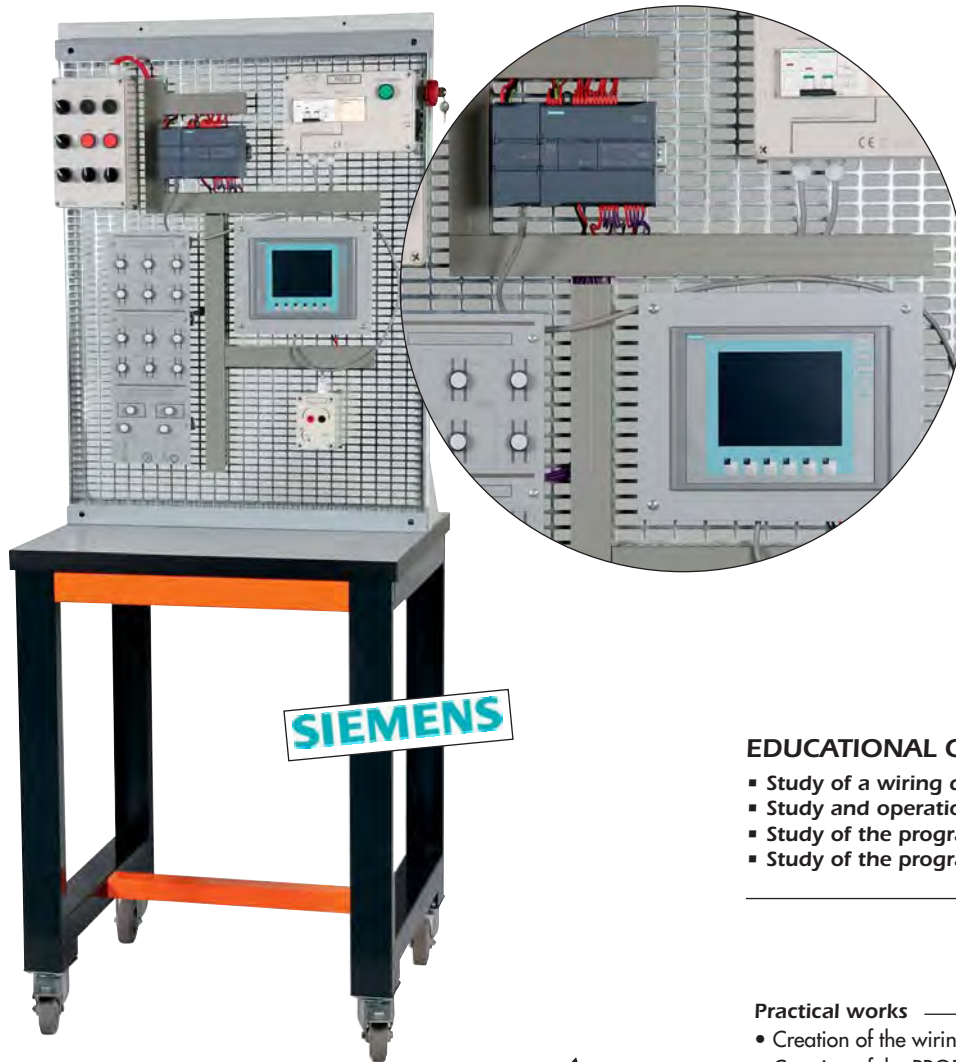

PROFINET is an open communication standard for industrial automation.

Developed by SIEMENS, PHOENIX Contact, MOLEX and other constructors, it provides automation solutions for processes, production and movement control.

Through its opening and the use of standard communications media (Ethernet), PROFINET enables the use of all brand of equipment.

MAQ-SI is a study system equipped with SIEMENS® components and designed for understanding the PROFINET system with programmable controller, touch screen and standard pushbuttons.

MAQ-SI uses the simulation of lighting commercial spaces to facilitate the teaching process.

SIEMENS

ref. MAQ-SI

ref. MAQ-SI-N (without table)

NEW

EDUCATIONAL OBJECTIVES

- Study of a wiring diagram developed in automation.
- Study and operation of a PROFINET® computer network
- Study of the programming of a SIEMENS® PLC.
- Study of the programming of an HMI (Human Machine Interface).

TEACHING RESOURCES STUDENT & TEACHER / VIDEO

Practical works

- Creation of the wiring diagram
- Creation of the PROFINET computer network
- Creation of the PLC programs in contact language
- Creation of the supervision from the HMI (Human Machine Interface).
- Change of IP addressing
- Test of the assembly

Features of the basement

- Base on wheels
- Dim L x l x H : 750 x 670 x 1950mm
- Weight : 60kg

Composition of the model

Power supply from the mains 230VAC – Mains lead 3m.

- 1 unit with magneto-thermal protection, residual current device 30mA and emergency stop.
- 1 SIEMENS PROFINET S7-1200 14 inputs/10 outputs PLC with analogue board 4-20mA / 0-10V.
- 1 SIEMENS KTP600 PROFINET touch screen 5.7 inches, 256 colours.
- 1 Day/Night simulation unit 4-20mA /0-10V.
- 1 printed face with 16 indicator lights.
- 1 control unit with 4 pushbuttons and 5 switches.
- 1 Ethernet RJ45 switch
- 6 Ethernet leads, 1.5 metres



Fieldbus study for PROFINET® & PROFIBUS® - SIEMENS® Components



ref. MAQ-NET

ref. MAQ-NET-N (without table)

SOFTWARE OPTION

LOG-STEP is highly intuitive. On-line help and the practical assignments let students learn quickly with the different programming screens. Single workstation licence. Compatible with Windows XP Home/Pro, 7 Home/Pro 32bits. Recommended PC configuration: Dual Core Processor 2Ghz or equivalent, RAM 2GB and screen resolution 1280x1024.

For programming the PLC and the touchscreen HMI.

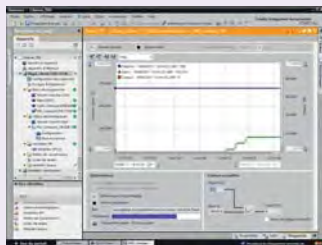

Programming of the PIF function

ref. LOG-STEP

EDUCATIONAL OBJECTIVES

- Studying of Fieldbus communication between different automatism components
- Studying of Profinet® and Profibus® wiring
- Settings of components Profinet® and Profibus®
- Programming of the set

TEACHING RESOURCES STUDENT & TEACHER / VIDEO

Features of the basement

- Base on wheels
- Dim L x l x H : 750 x 670 x 1950mm
- Weight : 64kg

Composition of the model

Power supply from three-phase mains 3 x 400V + N + E.

- 1 power supply unit with user and appliance protection (30mA) distributes voltage 24VAC to the speed controller (for the PLC, HMI*, offset I/O interfaces and 400VAC-3p+E) .
- 1 "machine" box with 3 PB, 3 switches, 7 indicator lamps and 3 PB and 3 switches for simulating sensors.
- 2 "machine" boxes each with 4 indicator lamps and 2 PB and 2 switches for simulating sensors.
- 1 PLC SIMATIC S7-1200. 14I / 10O. Integral Ethernet port.
- 1 Profibus interface
- 1 ETHERNET switch 4 ports RJ45
- 1 HMI colour touchscreen 5.7" with Profinet RJ45 port
- 1 interface ET200S 4I/4O offset with Profinet coupler
- 1 interface ET200S 4I/4O offset with Profibus coupler
- 1 speed controller SINAMICS G120C 0.55kW with integral graphic terminal.
- 1 Asynchronous motor 230/400V- 0.12kW with fan for viewing rotation.
- 1 set of Profinet, Profibus leads.
- 1 set of Profinet, Profibus connectors for mounting.
- 20 metres of Profinet, Profibus cable.
- 1 Starter software for programming the speed controller.
- 1 CD includes the instructions for the different components and the practical assignments and programming examples for the PLC, the speed controller and the HMI*

*HMI: Human Machine Interface

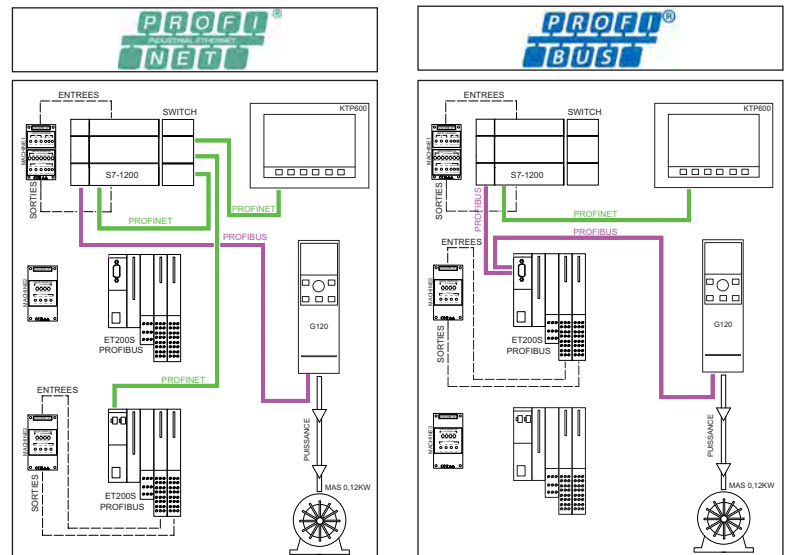

Fieldbus study for ETHERNET - SCHNEIDER® Components

EDUCATIONAL OBJECTIVES

- Studying of Fieldbus communication between different automatism components
- Studying of the ethernet wiring and IP network creation
- Settings of Ethernet components
- Programming of the set

TEACHING RESOURCES STUDENT & TEACHER / VIDEO

Features of the basement

- Base on wheels
- Dim L x l x H : 750 x 670 x 1950mm
- Weight : 65kg

Practical works

- Creating an company IP Ethernet network with multiple PCs
- Programming a PLC with a built-in or remote Ethernet bus on a TCP/IP interface
- Programming a HMI* interface, touch screen, with built-in Ethernet bus
- Programming of a speed converter from the So Move software
- Interconnecting and settings of components for a global operation
- Using the PLC programming software

In the practical works, the sequences of programming of each components is provided in the form of video files for a better understanding of the student.

*HMI: Human Machine Interface

Composition of the model

Power supply from mains 230V-2P+E.

- 1 power supply unit with user and appliance protection (30mA) distributes voltage 24VAC to the speed controller (for the PLC, HMI*, offset I/O interfaces and 230VAC-2p+E).
- 2 "machine" boxes each with 3 PB, 3 switches, 7 indicator lamps and 3 PB and 3 switches for simulating sensors.
- 1 PLC Ethernet 24 inputs /16 outputs
- 1 PLC Ethernet 14 inputs /10 outputs
- 1 ETHERNET switch 5 ports RJ45
- 1 touchscreen HMI 3.8" with Ethernet ports
- 1 speed controller ATV32-0.18kW
- 1 asynchronous motor 230/400V- 0.12kW with fan for viewing rotation.
- 1 multifunction programming graphic terminal with large monochrome screen (8 lines) 240x160 pixels for programming the speed controller
- 1 set of Ethernet leads.
- 1 set of Ethernet mounting connectors.
- 20 metres of Ethernet cable
- 1 software for PLC programming.
- 1 Vijéo designer software for programming the HMI.
- 1 SoMove software for programming the speed controller ATV32.
- 1 DVD includes the instructions for the different components and the practical assignments and programming examples for the PLC, the speed controller and the HMI* (video).

*HMI: Human Machine Interface



ref. MAQ-IP

ref. MAQ-IP-N (Without table)

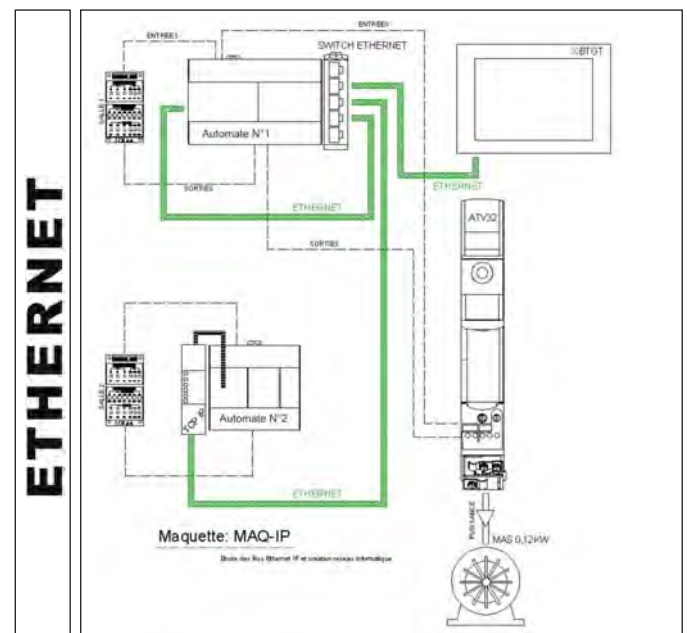

Cabinet for electrical authorization



The service voltage of 24VDC, protected by fuse and circuit-breaker, makes use of the cabinet completely safe. The integrated load, comprised of six 60W lamps, enables a sufficiently significant current to be generated. The cabinet is self-contained and requires no connection to the mains 230V when in use. A mains cable is nevertheless included for recharging the batteries using an integral charger. Available in 2 versions, fixed or mobile.

ref. HABILIT24 Fixed version

ref. HABILIT24-S Mobile version with base on wheels

EDUCATIONAL OBJECTIVES

- Put into application the knowledge, rules and methods for certification for authorization to electrical hazards
- Carry out practical assignments, wiring tasks relevant to electrical authorization
- Perform maintenance and cleaning operations in an industrial cabinet
- Perform removal from service operations of electrical equipment
- Take measurements using a clampammeter

TEACHING RESOURCES STUDENT & TEACHER

Practical works

- Reminder on electrical authorization
- Changing sets of copper busbars
- Removing the cabinet from service
- Complete the removal from service and authorization documents
- Check correct use of PPE
- Reading the current in the electrical cabinet using a clamp ammeter

Comprises

- 1 main source and one secondary source 24VDC distributed on 2 sets of flat copper busbars, 100A
- 2 disconnectors with visible cutting, for padlocking
- 2 special circuit-breakers DC 10A
- 1 set of protection devices by fuse + RC circuit-breaker 10A-10mA, IS type
- 4 gel batteries 12V/14Ah
- 3 dual switches
- 6 bulkhead lights 24VDC-60W
- 1 battery charger 230VAC/24VDC
- 1 panel of safety instructions for electrical authorization
- 1 2-colour light column indicating 24VDC 'on' and battery recharging
- 1 lot of 2 posts + 5m of red and white chain
- 1 insulating mat
- 1 insulating blanket
- 2 removal-from-service padlocks

Features

- 3-metre mains lead for battery charger
- Dimensions: HABILIT24: 450 x 700 x h 2000mm - Weight: 96 kg
HABILIT24-S: 600 x 800 x h 2120mm - Weight: 111 kg

Above HABILIT24-S version, mobile version.
Below HABILIT24 version, fixed.

Close up on disconnectors, busbar sets and panel of safety instructions attached to the cabinet bottom.

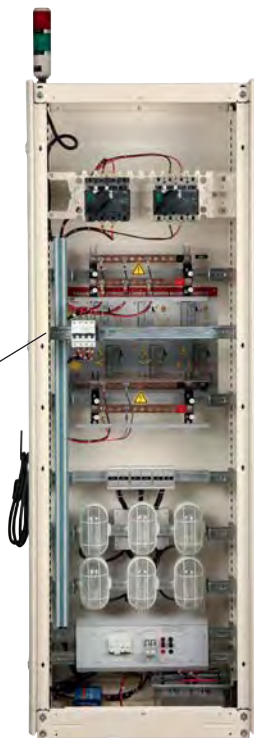
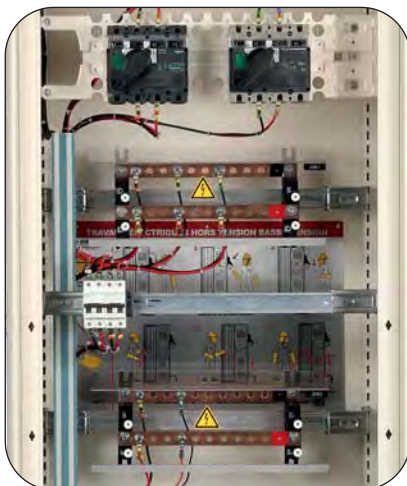

Study of the role of the earth & a differential circuit-breaker



EDUCATIONAL OBJECTIVES

- Educating students about the risks of electrocution in the event of direct contact
- Educating students about the risks concerning the quality of the earth
- Showing the role of a 30mA residual current circuit breaker in a house

TEACHING RESOURCES STUDENT & TEACHER

Theoretical recalls provided

- Operation of a magneto-thermal circuit-breaker rating, breaking capacity, tripping curve, symbols
- Operation of a residual current circuit-breaker rating, tripping time, symbols
- Physiological effects of the current hazard zones: current function times, dangerous voltages
- Maximum resistance of the earth

Practical work supplied

No earth and no insulation fault

- potential risk

Earth < 100Ω and net insulation fault

- with person in contact with the metal enclosure of the machine
- with no contact

Appearance of a fault current greater than 30mA, tripping of the differential.

Demonstration of the short circuit

Earth < 100Ω and low insulation fault

Appearance of a fault current less than 30mA, no tripping of the differential.

Measurement of the fault current in the person in contact with the machine

Earth > 100Ω and low insulation fault

Appearance of a fault current less than 30mA, no tripping of the differential.

Measurement of the fault current in the person in contact with the machine

Earth > 100Ω and net insulation fault

- with person not in contact with the metal enclosure of the machine measurement of the fault current
- with person in contact with the enclosure: measurement of the fault current greater than 30mA, no tripping of the differential. LED symbolizing the heart, coming on.

Others characteristics

- Power supply : 230VAC 50Hz
- Dimensions : 390 x 270 x 100mm
- Weight : 2.3kg
- Supplied with 5 resistive modules, coupling jumpers & leads

ref. SELDIF

The front synoptic shows

- the public network, with its medium voltage/low voltage transformer substation, and the neutral to earth connection, in this substation.
- the transmission line from the transformer substation to the dwelling
- the domestic installation, with the residual current circuit-breaker 30mA, the local earth, and a washing machine. The TT neutral system is the same as that of a domestic installation
- A person in the right-hand part has an LED for a heart. If a dangerous leakage current flows here, the LED comes on
- A two-pole industrial residual current circuit-breaker 30mA is located in the centre of the synoptic.
- Two jumpers enable the washing machine to be fully isolated, and current measurements to be taken.
- An ON pushbutton starts the washing machine, and a green LED comes on, symbolizing rotation of the machine.

Safety terminals 4mm, located on the front, let the student measure the fault currents, and insert different resistive modules. These modules simulate two earth resistance values, and two leakage current values. One module with variable resistance enables the differential's tripping current to be measured.

To prevent any risk of electrocution to the student, the model operates at extra low voltage using an isolating transformer to standard NFC61558.

Supermarket checkout simulator

OPERATIVE PART ONLY

EDUCATIONAL OBJECTIVES

- Understanding, putting into service, getting started and setting of the system
- Making different wirings and functioning tests
- Illustration and visualization of the result of a PLC program

USER'S MANUAL + PW

Proposed Practical Works

- Studying and locating of the different components
- Wiring of cells, light signal tower and gearmotor
- Making different wirings corresponding to various operating scenarios of the system



Features of the basement

- Frame on wheels
- Dimensions : 1600 x 650 x 1150mm (Height without indicator light)
- Weight : 60kg

ref. TAPIX

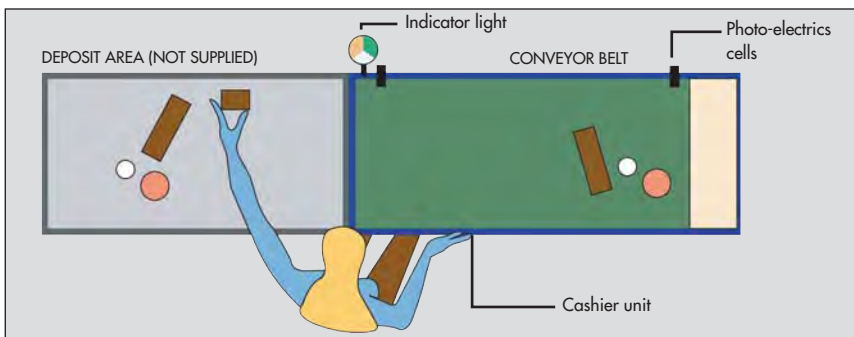

TAPIX is a conveyor belt for a cash register with the same features as the ones you would find in a supermarket. It comprises a conveyor belt driven by a gear motor, a control unit used by the cashier, an indicator light showing the status of the cash till and start and end of belt sensors.

The TAPIX system will only operate once the console has been connected to an external electrical cabinet.

MIMIC CONSOLE ALLOWING ELECTRICAL CONNECTION

- 1 HARTING® rapid connector (on the console) for connecting sensors, the cashier unit and the status indicator light.
- 1 set of safety terminals (on the console) bringing together the wiring for the motor's terminal board.
- This area can take a HARTING® rapid connection interface if the user does not have any electrical measurements to take from the motor.

CASHIER UNIT CONNECTED TO THE CONSOLE

It comprises all of the various controls that the cashier requires.

- "Till open" push-button
- "Last customer" push-button
- "Information request" push-button
- 3-position switch:
 - (1) Forced belt operation:
The belt will continue to move forwards.
 - (2) Automatic operation of belt:
The belt will move forwards depending on the objects that are placed on it
 - (3) Switch off belt

STATUS INDICATOR LIGHT CONNECTED TO THE CONSOLE

Indicates the status of the till to customers

- Green = till open
- Orange = last customer
- White = Call

PHOTO-ELECTRIC CELLS CONNECTED TO THE CONSOLE

- Placed at the start and end of the belt, they detect
 - the presence of an item on the belt, which in turn activates the belt
 - that items are building up at the end of the belt, which in turn shuts down the belt
- These cells are of the NO, dry contact output type

GEAR MOTOR

Three-phase 230/380V. The motor's terminal board, which protrudes onto the console, enables the user to add an ammeter or a wattmeter in order to measure the current and power.

SET OF CABLES

Set of two 3-metre-long cables supplied with TAPIX



MODEL WITH TEST CABINET

These versions are identical to TAPIX, only the connection console is replaced by a control panel and a test cabinet. The setting up of the grid is immediate.

It's an autonomous system.

4 Harting® connectors connect the grid to the test cabinet end the control panel. The right panel of the test cabinet is equipped with the buttons and the indicator lights necessary to the startup of the student's grid.



ref. TAPIX-ARM-GD

ref. TAPIX-CAB model with wired grid

FEATURES OF THE POWER CONSOLE

- Console which is used for safe testing and supplies the three-phase and 24V power.
- Circuit breaker, in front of the power source
- General residual current circuit breaker protection.
- General emergency stop and Start/Stop
- 2 circuit breakers for protecting the three-phase and 24V power supply
- Cabinet door safety contact control.

FEATURES OF THE TEST CABINET

- 800 x 600 x 250mm steel cabinet
- Plate on door with actuators and control lamps wired to the HARTING® connector.
- Free spaces for the addition of control accessories DIAM 22.
- Rapid hanging and connection of a grid no bigger than 750 x 550mm.
- Door safety contact (power to the cabinet is cut off automatically if the door is opened)
- 4 fixed connectors on grid, to be wired by students
- 4 rapid connection jacks to the sensors, controls and motor.

KEY-OPERATED DOOR OVERRIDE

- Allows the live cabinet to be used with the door open if the switch has been activated. Operates with a different key to the No.455.

MODEL WITH TEST CABINET AND MONITORING



Some versions as TAPIX-ARM-GD. **It's an autonomous system.**

USER'S MANUAL + SUPERVISION PW

REF.	TAPIX-S	TAPIX-S-T6
PLC programming software	▪	▪
Software for touchscreen		▪
Software for PC	▪	
5.7 inch colour touchscreen		▪

MONITORING ON TAPIX SYSTEMS ENABLES THE USER

TO DISPLAY

- till open information
- last customer information
- information request details
- Presence of items on the belt
- The build-up of items on the belt
- Motor operation
- Mains power on 400V
- 24V mains power on

TO CONTROL

- till open information
- last customer information
- information request details
- the operation of the motor

You can also create your own monitoring.

5.7-INCH TOUCHSCREEN COLOUR

- High-visibility 256-colour TFT screen
- Communication, via RJ45 connector, for the TCP/IP ETHERNET network
- Adjustable contrast and brightness
- 24V DC/0.3A power supply
- Dim. 130 x 104 x 41mm

The systems which include a monitoring function are all supplied assembled and fully wired. Detailed instructions with full features of each component and tutorial supplied.

The monitoring is fully developed and operational.

Drinking water supply simulator (VijeoDesigner-Schneider®)

SYSTEM DESCRIPTION

- 1 150-litre tank simulates the river.
- 2 transparent tank (60 L) simulates the settling basin and the water tower
Fitted with 3 water-level sensor (all or nothing).
- 2 motorised pumps draws the water (river to the basin / basin to the water tower)
- 1 tap drains the water tower.
- 2 all or nothing flow sensors.
- 1 valve drains the settling basin.
- 2 valves at the motorised pump output to adjust the flowrate of the water.
- 2 emergency overflows.
- 1 test cabinet, with PLC, Analog card and Ethernet...
- Protection main control panel with circuit breakers including one 30mA control and consignment.

THE MONITORING ENABLES TO DISPLAY

- The water-levels
- The settling basin pump feed
- The water tower pump feed
- Movement of the water from the river into the settling basin
- Movement of the water in the settling basin to the water tower
Low water level warning message for each tank

THE MONITORING ENABLES TO CONTROL

- the settling basin pump feed manually
- the water tower pump feed manually
- the cycle start
- MANUAL / AUTOMATIC / MAINTENANCE mode

THE MONITORING ENABLES TO SIMULATE

- the detection of the 6 water level sensors

Features of the PLC supplied

- sequential function chart or ladder language programming
- 230V mains power supply.
- 14 inputs 24V DC on terminal
- 10 binary outputs 230V/2A on terminal
- RJ45 Ethernet output, used for connecting the PLC to the IP computer network.
- The programming software and index in the form of ladder language is supplied.

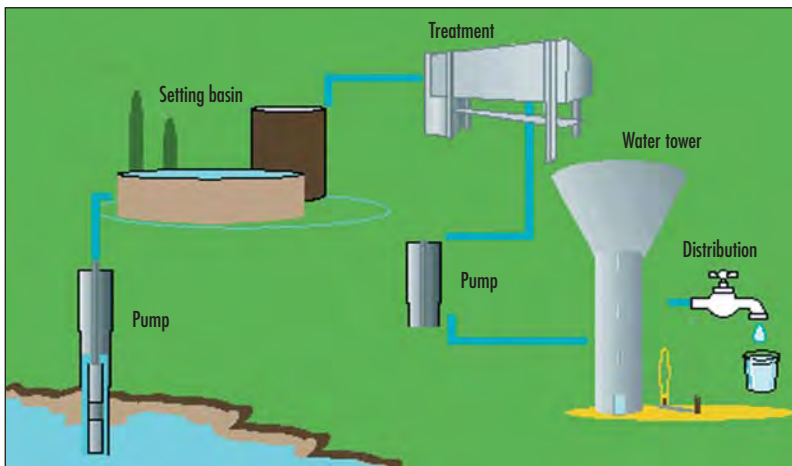

The water that comes out of our taps is drinkable and has travelled a long way. In some cases, it is pumped from rivers and then undergoes various treatment processes before it becomes fit for drinking. It flows into a settling basin, at the bottom of which the heaviest materials are deposited, then it is filtered through layers of sand and sterilised, in order to remove bacteria. This clean water is then transported by means of pipes and pumping before it is stored in a water tower. These provide consumers with a constant pressure. The CHATO system enables students to simulate this entire circuit, from the stage where water is pumped from rivers to the stage where it arrives in people's homes.

TRANSPARENT TANKS MADE FROM UNBREAKABLE LEXAN



System characteristics

- Frame on wheels.
- Dim 1500 x 750 x 1970mm.
- Weight : 190kg.

EDUCATIONAL OBJECTIVES

- Understanding, putting into service, getting started and setting of the system
- Understanding the settings and the programming of the PLC
- Know more about the monitoring application

USER'S MANUAL + MONITORING PW

Proposed Practical Works

- Setting of the PLC
- IP addressing management
- Loading, modification, monitoring creation

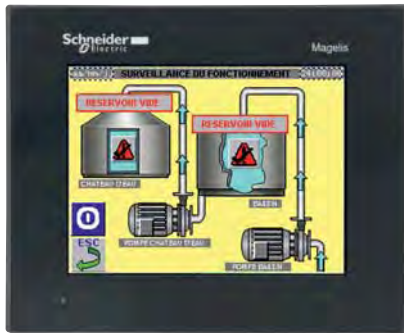

MONITORING ON TOUCHSCREEN

REF. CHATO-4S-T6

- PLC programming software
- Monitoring software VijeoDesigner
- 5.7 inch colour touchscreen

The monitoring software delivered with the set allows to modify the initial program and to create your own programming.



MONITORING ON PC ONLY

REF. CHATO-4S

- PLC programming software
- Monitoring software VijeoDesigner

The system is the same than in the version above but without the touch screen. The monitoring is made on PC with the software SCHNEIDER VijeoDesigner.

FEATURES OF THE DIFFERENT COMPONENTS

PUMPS & FLOW CONTROL VALVES



- 2 PUMPS
- 230/400V 3-phase motor (SINGLE-PHASE UPON REQUEST)
 - Power 750W
 - Stainless-steel body and turbine
 - Auto-start

FLOW CONTROL VALVES

- 1 for setting tank pump
- 1 for water-tower pump

SENSORS



- Dry-contact horizontal level sensors.
- max voltage 24V
- Max current 3A

ALL OR NOTHING FLOW SENSOR



Detects water flowing in the PVC pipe of the CHATO circuit. An NO or NC contact at the sensor output sends information to a PLC or a contactor.

DRAIN VALVES



Used to drain the tank, e.g. to simulate reservoir maintenance.

TAP

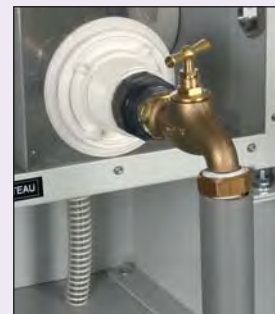

Simulates domestic water consumption. Connected by hoses to the tank that simulates the river.

150L TANK



- Simulate the river.
- Plastic tank with drain plug.
- Installed on a base so it can be moved with the system.

OPTION FLOWMETER



The sensor shows the flowrate of the water on the display unit when it leaves the pump. Students can observe a change in the flowrate, depending on the valve setting. 4-20mA signal output on Ø4mm safety terminals.

ref. CHATO-DEBIT

HYDROSTATIC PRESSURE SENSOR OPTION

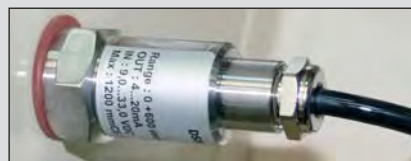

ref. CHATO-NIV

This option, supported by the PLC and the monitoring program, measures the water level. The monitoring screen displays the levels in the tanks proportionally to the pressure. Possibility to install 2 sensors, one on each tank (Basin / Water tower).

- Piezoelectric measuring cell
- Scale precision +/- 0.5%
- 4-20 mA

Drinking water supply simulator with electrical cabinet (not wired)

Version without monitoring

TRANSPARENT TANKS MADE FROM UNBREAKABLE LEXAN



ref. CHATO-4-GD

Open solution to traditional cabling solution in electrical engineering wiring.

- Door panel prewired
- Free spaces for adding some control components (Diam 22mm)
- The grid is easy to disconnect due to Harting connectors and plugs for the level sensors, the moto- pumps and the power supplies 400V and 24V.

SYSTEM DESCRIPTION

- 1 150-litre tank simulates the river.
- 2 transparent tank (60L) simulate the settling basin.
Fitted with 3 water-level sensor (all or nothing).
- 2 motorised pumps draws the water
(river to the basin / basin to the water tower)
- 1 tap drains the water tower.
- 2 All or nothing flow sensors.
- 1 valve drains the settling basin.
- 2 valves at the motorised pump output to adjust the flowrate of the water.
- 2 emergency overflows.
- 750 x 1500mm base on wheels enables you to move the system
- 1 test cabinet not wired.
- 1 electric console with control and protection.

EDUCATIONAL OBJECTIVES

- Understanding, putting into service, getting started & setting of the system
- Wiring of different components and connection

USER'S MANUAL + PW

Proposed Practical Works

- Wiring of electrical components according the different operating modes
- Troubleshooting and maintenance

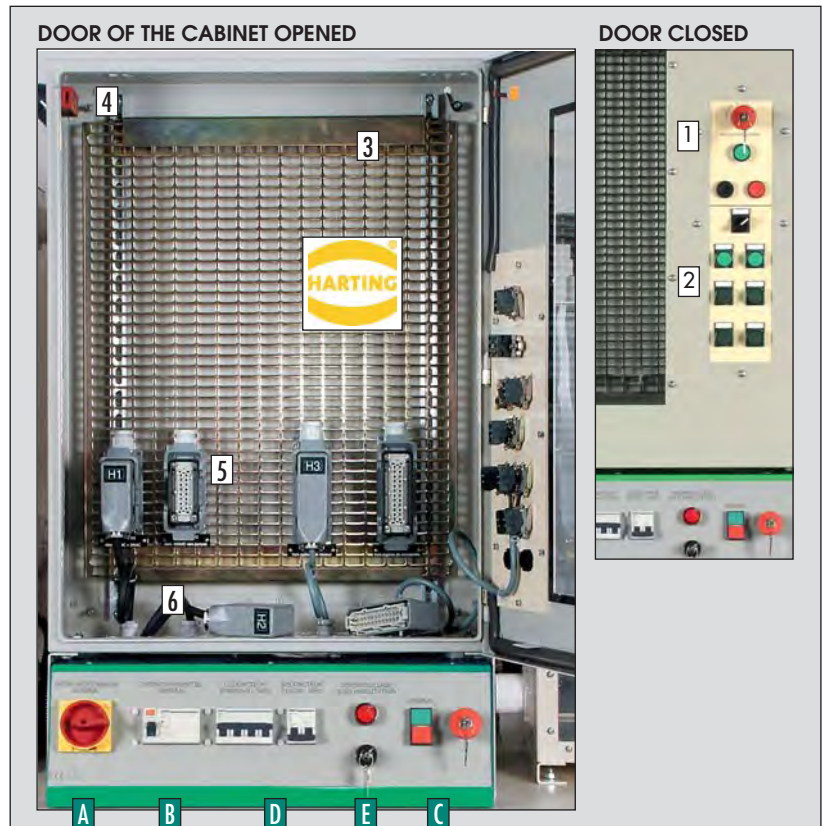

TECHNICAL FEATURES OF THE CABINET

800 x 600 x 250mm steel cabinet, supplied with a grid.

- 1 Plate on door with unwired control lamps and actuators.
- 2 Free spaces for the addition of DIAM 22 control components
- 3 Rapid connection and hanging of the grid (not exceeding 750 x 750mm).
- 4 Door safety contact
- 5 Fixed connectors on grid, to be wired by students
- 6 Male Harting® connectors to level sensors, to motorised pumps, to the 400 and 24V power sources and to the control panel.

TECHNICAL FEATURES OF THE CONSOLE

Console which makes testing safe, with control of the cabinet door's safety contact.

- A** Circuit breaker, in front of the power source
- B** General residual current circuit breaker 30mA.
- C** General emergency stop and Start/Stop
- D** 2 circuit breakers for protecting the three-phase and 24V power supply

E DOOR OVERRIDE

*Key-operated door override switch. Allows the live cabinet to be used with the door open if the switch has been activated.
Operates with a different key to the No.455.*

Drinking water supply simulator (operative part only)



SYSTEM DESCRIPTION

- 1 150-litre tank simulates the river.
- 2 transparent tanks (60L) simulates the settling basin and the water tower. Fitted with 3 water-level sensors (All or Nothing).
- 1 moto-pump draws the water from the "river" to the "basin".
- 1 moto-pump draws the water from the "river" to the "water tower".
- 1 tap simulates the water consumption. The water flows from the "water tower" to the "river".
- 1 valve drains the settling basin. Flow rates are adjusted by 2 valves at the output of moto-pumps.
- 2 safety overflows devices on the upper parts of tanks avoid any overflow.
- 1 set of 2 cables (3m) equipped with female Harting connector can connect the operative part on your connection box of a control unit.
- 750 x 1500mm base on wheels enables you to move the system easily.
- 1 mimic console + quick connection interface.

MIMIC CONSOLE

All the connections and measuring are made on this user-friendly mimic console.

- 1 male HARTING connector on the left section is connected to the 6 water level sensors.
- A synoptic indicates the function of each connection and the main features of the system.
- 12 safety terminals and 1 earth socket (4mm) are connected to the electrical windings of the moto-pumps. The student is able to measure the currents with a multimer.

CONNECTION BY SAFETY SOCKETS OR BY MEANS OF THE QUICK CONNECTION INTERFACE

- A quick connection interface (4mm terminals / male Harting) is plugged on 13 connection sockets for the connection to a control cabinet (not supplied). A detailed synoptic on the interface shows the function of each connection.



RAPID CONNECTION INTERFACE FOR THE PUMPS

This unit is plugged directly into the mimic console, transforming the 12 safety terminals 4mm into a HARTING® industrial rapid connector



SET OF 2 CABLES



Set of 2 3-metre-long cables supplied with CHATO.

- 1 interconnection cable for sensors
- 1 interconnection cable for motors

Options for drinking water supply simulator CHATO-4 & CHATO

ALL OR NOTHING FLOW SENSOR

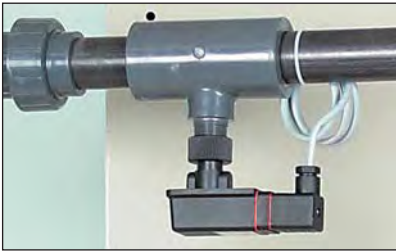

ref. CO-DEB

Detects water flowing in the PVC pipe of the CHATO circuit. An NO or NC contact at the sensor output sends information to a PLC or a contactor.

Features

- Can be fitted in any position
- PVC connection Diam: 40mm to be stuck on
- Switchable, potential-free contact
- NO or NC 1A/230VAC
- Electrical connection via a DIN connector

GRID & PLATE FOR PLCs



Wired door plate and grid for system operation with a PLC. Supplied with programming and training software.

ref. CHATO-AUTO

GRID & PLATE FOR RELAY

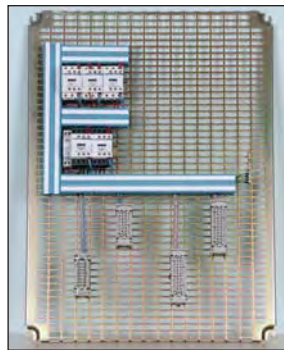

Wired door plate and grid for system operation with relay.

ref. CHATO-REL

FLOW INDICATOR WITH FLOAT



A moving float in a transparent tube indicates the pump's water flowrate in cubic meter/hour

Features

- Upright fitting
- Measuring scale: 0.6 to 6 cubic meter/hour
- Ascending fluid
- Float and stop
- PVC connection Diam: 40mm (to be stuck on)

ref. FLO-DEB

FAULT SIMULATOR UNIT



Unit with concealed switches to simulate sensor faults. 6 switches linked to 6 sensors. Unit fixed onto the system's frame.

ref. CHATO-PAN

SUMMARY AND HELP IN THE SELECTION OF THE DIFFERENT CHATO SYSTEM PRESENTED PAGES 164 TO 167

Ref. CHATO-4S-T6



Simulator with electrical cabinet and monitoring on touchscreen

Ref. CHATO-4S



Simulator with electrical cabinet and monitoring on PC only

Ref. CHATO-4-GD



Simulator with electrical cabinet

Ref. CHATO



Operative part only

Didactic lift

USER'S MANUAL + 7 PRACTICAL WORKS

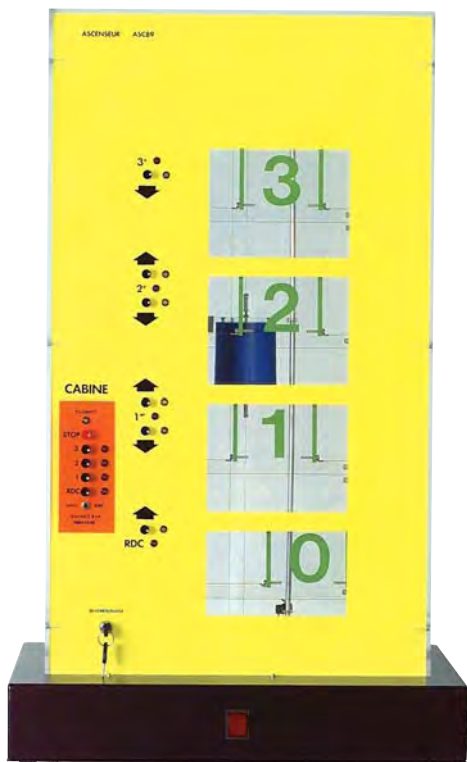

ref. ASC89-24 LOGIC CONTROLS IN 24V

ref. ASC89-05 LOGIC CONTROLS IN 5V

The ASC89 lift is a model which may be connected to a PLC or any microprocessor system. It comprises 24 outputs and 21 inputs. You can only use a part of input/outputs if you want to do easy programmes

MAIN FEATURES :

- Opening and closing of the doors on each floor is done by electric servo motors.
- The rear of the lift is visible through the sides and the bottom which are transparent
- The route of the lift is sensed at each floor by a photo-detectors.
- Two limit switches, high & low, (without program control) stop the lift if there is an error in the program.
- All of the buttons and switches are fitted with de-bounce circuits.
- The outputs are protected against the possibility of a short-circuit.
- The rear sliding door is of a transparent Plexiglass design and there is no manual access possible, as there is risk of damaging the servomotor.

The mechanical controls are sturdy and can withstand any likely faults.

4 LEVELS EACH LEVEL HAS	1 electrically opening door - 1 photo-detector for 'door closed' - 1 photo-detector for 'door-open' 2 safety limit switches for door open/close (No control from the program possible) 1 button to call the lift 'up' (except the 3rd floor) with indicator lamp. 1 button to call the lift 'down' (except the ground floor) with indicator lamp 1 lamp to indicate the presence of the lift - 1 photodetector to indicate the presence of the lift
CONTROLS INSIDE THE LIFT	4 buttons for each floor - 1 stop button 1 switch to simulate a blocked door 4 lights for each floor - 1 light inside the lift (simulating the lighting)
UNIT SUPPLIES POWER TO	the motors - the LED - internal logic to the unit.
OTHERS SPECIFICATIONS	Dims 780 x 480 x 440mm Weight 15kg Supply 230V 50Hz The unit is available in two driving logic values, 24V or 5V.

INTERFACES FOR DIDACTIC LIFT (CHOOSE ONE OF THEM)

CHOICE N°1

ASMAT is an interface allowing a quick connection to the ASC89 lift from a PLC. To help in quickly identifying the functions of the connectors, small symbol and piece of text next to each connector, allowing immediate understanding of its function. The operating sense: Lift - PLC or PLC - Lift. It is clearly indicated by vertical arrows. Metal box: 22 x 272 x 32mm. Weight: 250g.

CONNECTION	CONNECTION
ASMAT - LIFT	ASMAT - PLC
Two flat cables with: One connector for the inputs and the other for the outputs.	The front face of the board has two columns of 4mm plugs, which are used to connect to the PLC with normal leads. The plugs on the left are for the inputs to the PLC, on the right for the outputs.

ref. ASMAT

PLC which can control the 24V lift via ASMAT interface. Réf. M221-MAX see page 172.

CHOICE N°2

AUTOMASC is delivered in a plastic box including:

- a 30 inputs / 26 outputs PLC (dry contacts)
- a USB connection interface with the PC
- supplies for the PLC outputs
- All cables to the lift, mains cable.

It is connected to the lift rear connectors with 2 flat cables, one for inputs, the other one for outputs.

PROGRAMMING

User can program AUTOMASC with 2 languages: Instructions list or contact language. You can program it from PC, using the software (included). Delivered with a program designed for complete functioning of the lift.

OTHER FEATURES

The front panel is transparent to see many LED, showing the PLC state. AUTOMASC is supplied with a demo program, which can be modified or completed. The technical leaflet indicates the corresponding between the lift inputs and outputs and the ones of the PLC, allowing the development of a complete program.

Mains: 230/240V - 50Hz - 50VA - Dimensions: 250 x 180 x 175 mm - Weight: 2.7kg

ref. AUTOMASC

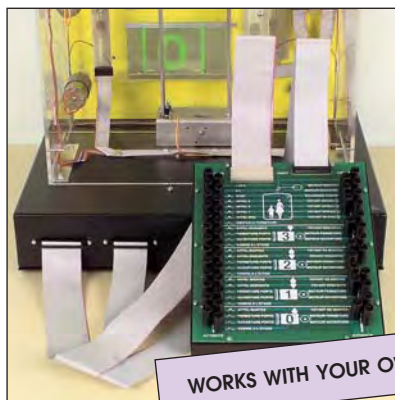

WORKS WITH YOUR OWN PLC



INTERFACE WITH BUILT-IN PLC

Motorized gates



ref. PO-PB2

- Double casement
- Current consumed 0.8A
- Max power 200W.
- Speed reduction ratio 1/296



ref. PO-PC1

- Sliding
- Current consumed 1.5A
- Max power 290W.
- Speed reduction ratio 1/30

EDUCATIONAL OBJECTIVES

- Understanding, putting into service, getting started and setting of a automatic or semi-automatic portal
- Interconnecting of the different components in jumper wires mode

USER'S MANUAL + 4 PRACTICAL WORKS

Tutorials are supplied with automatic functions

- Wiring of all of the components
- Adjusting the various operating settings
- Measuring the properties of gear motors and comparing these values with the ones for the rating plate.
- Looking for one or more faults

Features common to both gates

- Emergency stop circuit breaker
- 230V AC mains power supply
- Power supply to photoelectric cells: 24V AC. (internal power supply).
- Fault simulator unit with 4 circuit breakers, causing a fault on each cell.
- Life-time pre-lubrication using grease.
- Dimension of the unit: 1400 x 800 x 1700mm / Weight 90kg
- Sold with all connection diagrams and all the various settings to be entered for the smooth operation of the gates.

Components involved in the automatic operations (common to both gates)

- 1 frame on wheels with brake.
- 1 or 2 gear motors, depending on the selected automatic operation model.
- 2 pairs of photoelectric cells, to secure the opening and closing of the gate.
- 1 unit fitted with an electronic card controls the operation of all of the different settings (such as closure time-delay, activating the remote control, etc.).
- 1 gate opening and closing remote control
- 1 gate operation indicator light.
- 3 consoles, consisting of 4mm safety terminals for the 230V and 2mm for the extra-low voltage, containing the wiring for:
 - the key-operated "gate opening and closing" push-button
 - the gear motor(s), the light, the 24V power supply for the cells and the mains power supply
 - for the 4 photoelectric cells
- 1 fault simulator unit enables the user to create a malfunction in the photoelectric cells.
- 1 set of keys for unlocking the door mechanically.

Pneumatic handling line

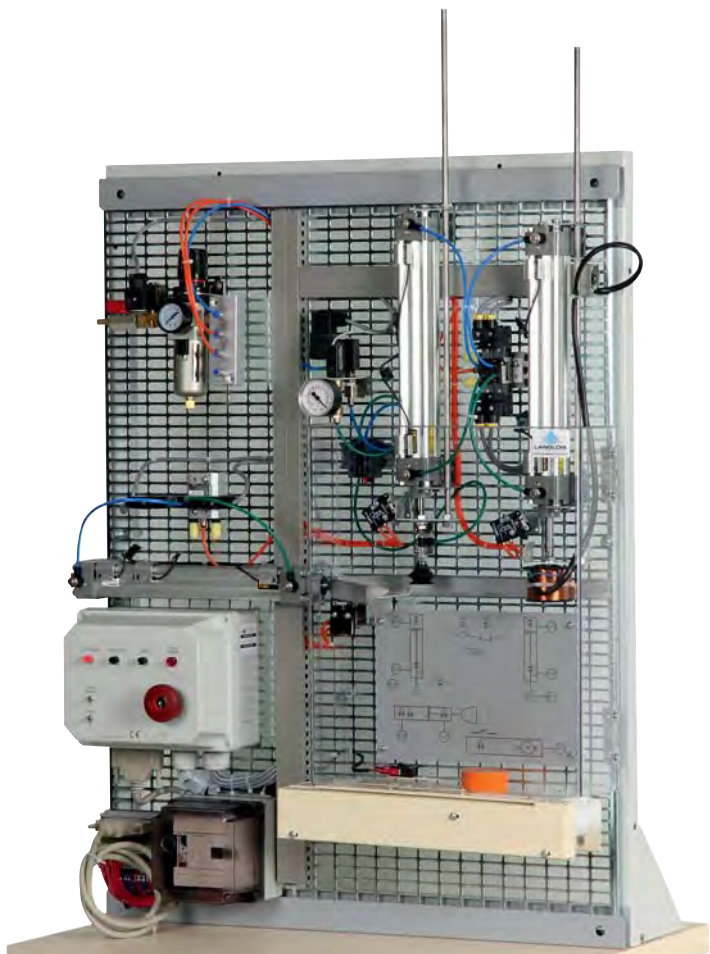

ref. PNEU99 with PLC and software

ref. PNEU98 without PLC

EDUCATIONAL OBJECTIVES

- Introduction to pneumatic components
- Programming approach by PLC
- Monitoring of the system in manual or automatic mode

USER'S MANUAL & THEORETICAL COURSES

The model is delivered ready for use (the electric part is completely wired and all the pneumatic connections made). The quick-fit joints allow dismantling/reassembly of pneumatic interconnections with $\varnothing 4\text{mm}$ tubes of various colors.

A manual gives details of the operation of all the electro-pneumatic components used and their adjustment. Several cycles are described, including one complete with its grafset.

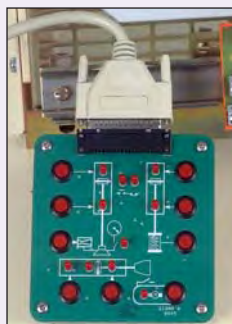

MANUAL CONTROL BOX SUPPLIED

This box contains

- 9 push buttons corresponding to each actuator
- 11 indicator lights which give information about the state of the sensors

It allows very slow observation of pneumatic phenomena and learning about the basic regulation of flow control, actuator speed, and detector positions.

OPERATING CYCLE

The parts placed on the conveyor belt are held by the vacuum suction grip of a first pneumatic jack, then placed on the horizontal jack, grasped by the electromagnet jack undergoing a complete handling cycle before being returned to the belt.

PNEUMATIC COMPONENTS

- 3 double effect pneumatic jacks $\varnothing 32\text{mm}$. Travel 250mm, each equipped with:
 - flow reducers allowing fine adjustment of their movement
 - magnetic position detectors (2 or 3 per actuator) with LED
 - quick-fit joints for $\varnothing 4\text{mm}$ tubes
- 2 5/2 electropneumatic distributors
- 1 5/3 electropneumatic distributor
 - All distributors are fitted with
 - 24V DC coils
 - LED visual display of the state of the coils
 - quick-fit joints for $\varnothing 4\text{mm}$ tubes
 - fitted on mountings with silencers
- Vacuum generator
 - One of the actuators is fitted with a suction grip with its vacuum system. An adjustable threshold vacuostat delivers an electrical presence or absence of vacuum signal. A vacuummeter allows visual checking on the vacuum.
- Jacks protection
 - To avoid any risk of destroying a pneumatic jack, an entirely pneumatic logic system (without student access) prevents the simultaneous movement of the horizontal jack with a vertical jack.

ELECTRIC BOX

- Contains a regulated 24V DC 2A source to feed the PLC if necessary if it does not have an internal supply. The necessary supplies to the model.
- A Start cycle button, a Stop cycle button,
- a reset button.
- a general emergency button stopping the electric and pneumatic supplies.
- The connector which the user connects to the PLC or to the manual control box.

USER'S PROTECTION

- A transparent color door is a barrier between the pneumatic jacks and the user's hand. The opening turns off the air pressure

PLC (only for PNEU99 version)

- 14 inputs / 10 outputs (RELAYS)
- 2 languages : Grafset instructions, contact language.
- Programming : from a PC using a software (included).
- Delivered with a complete and functional program.

OTHER CHARACTERISTICS

The conveyor belt is either controlled by the automatic system and the end of belt detection switch or by being forced into operation. An electromagnet illustrates picking up by a magnetic field. PNEU** is connected to the air network by splined terminal placed on the valve block of stop + regulator + filter + distribution output by quick coupling. PNEU** is delivered on a 1000 x 750mm chassis with lateral fixing brackets on a table.



OPTION COMPRESSOR

ref. PRESS-35

PLC UNITS

Integrated PLC units

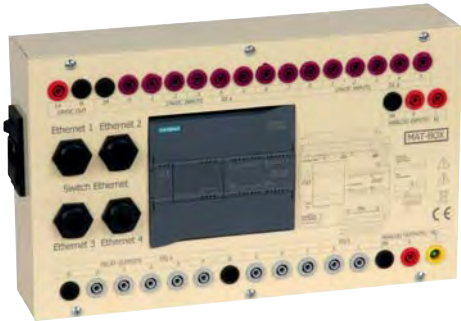

MAT-BOX

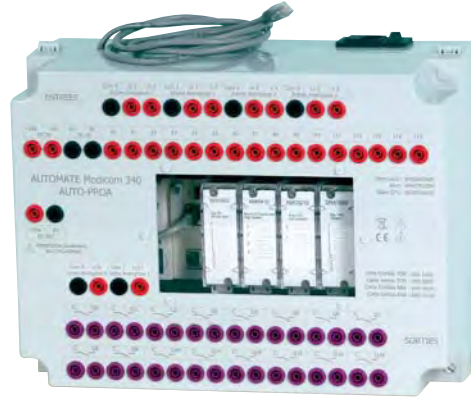

AUTO-PRO-A



AUTO-238-A

Ref.	MAT-BOX	AUTO-221	AUTO-221-A	221-MAX
Brand	SIEMENS	SCHNEIDER		
Model	SIMATIC S7-1200	M221		
Number of Inputs	14 inputs 24VDC			30 inputs 24VDC
Number of outputs	10 All or Nothing outputs 2A max on resistive load	10 All or Nothing outputs 2A max		26 All or Nothing outputs 2A max
Analog	2 inputs 0-10VDC 1 output 0-10VDC or 4-20mA	no	2 inputs PT100 1 output 0-10VDC or 4-20mA	2 analog inputs 0-10V
Ethernet	yes + 1 mini switch 4 ports RJ45	yes		
Software	LOG-STEP (in option)	SoMachine Basic (supplied)		
Power supply	230VAC-50/60Hz by means of socket unit+ switch			
Dimensions	330 x 200 x 80mm	330 x 200 x 80mm		380 x 280 x 180mm
Supplied with	1 Ethernet RJ45 3-m cable. 6 detailed practical works (PLC configuration, use and programming.)	1 Ethernet RJ45 3-m cable. 1 USB cable PC/PLC		

Integrated touchscreen units

Ref.	TOUCH-BOX	STU-BOX4	STU-BOX6	
Brand	SIEMENS	SCHNEIDER		
Modèle	Simatic KTP600	HIMISTU		
Touchscreen	5,7" TFT 256 colours	3,5" 65536 colours	5,7" 65536 colours	
Resolution	320 x 240 pixels			
Ethernet	1 RJ45 connector	6 RJ45 connectors (Including 1 5 ports switch)	1 RJ45 connector	
USB	-	1 USB connector		
Software	LOG-STEP (in option)	VijeoDesigner (supplied)		
Power supply	230VAC-50/60Hz by means of socket unit + switch			
Dimensions	330 x 200 x 80mm			
Supplied with	1 Ethernet RJ45 3-m cable. User's manual with tutorials.	1 Ethernet RJ45 3-m cable.		

SOFTWARE OPTIONS



For PLC
MAT-BOX
For Touchscreen
TOUCH-BOX

ref. LOG-STEP

Very intuitive, it proposes an online help and tutorials allowing the user to start quickly with the different programming screen.



For PLC
AUTO-PRO
AUTO-PROA

ref. UNITY-SMALL

Very intuitive, it allows a multitasking programming. It can convert easily your programs made under PL7.



For PLC
AUTO-238
AUTO-238A
AUTO-221
AUTO-221-A
221-MAX

ref. SOMACHINE

Effective and open professional software solution which includes Vijeodesigner. Include the programming of controllers and HMI interface (Human Machine Interface)

Réf.	AUTO-PRO	AUTO-PROA	AUTO-238	AUTO-238-A
Brand	SCHNEIDER			
Model	MODICOM M340		M238	
Number of Inputs	16 isolated inputs 24Vcc		14 inputs 24V	
Number of outputs	16 outputs 2A max - TOR		6 all or nothing outputs + 4 static outputs (24V)	
Analog	-	4 voltage / current inputs ±10V / 0-10V / 0-5V / 1-5V / ±5V 0-20mA / 4-20mA / ±20mA 2 voltage / current outputs ±10V / 0-20mA / 4-20mA	-	2 inputs 4-20mA / 0-10Vcc 1 output 4-20mA / 0-10Vcc
Ethernet	Ethernet module TCP/IP on RJ45		1 Ethernet port + 1 Modbus port	1 Ethernet port
Software	UNITY SMALL (in option)		SoMachine (in option)	
Power supply	230VAC-50/60Hz by means of socket unit + switch			
Dimensions	360 x 270 x 170mm		330 x 200 x 80mm	
Supplied with	1 ethernet RJ45 3-m cable.		1 ethernet RJ45 3-m cable. 1 USB cable.	



TOUCH-BOX



STU-BOX4



STU-BOX6

Programmable controls system

BASIC MODEL

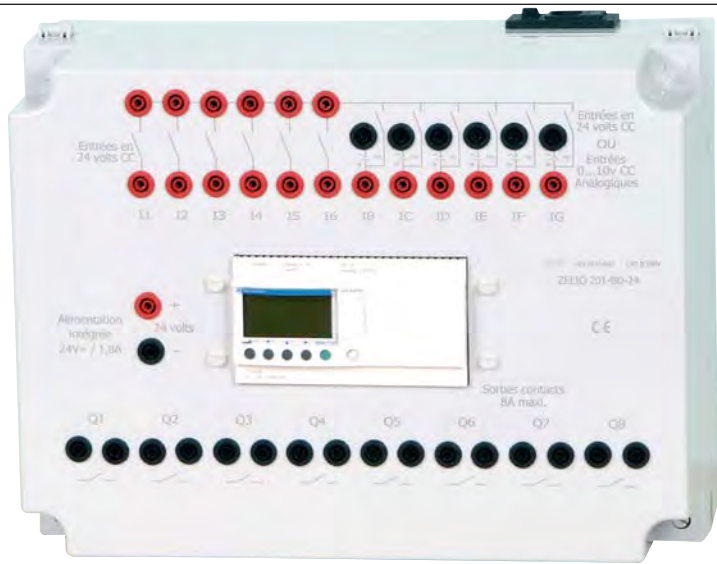

ref. ZELIO-201-24



This unit is a programmable interface working as a PLC with orders (inputs) and contacts (outputs). Its particularity is to integrate a clock which sets controls. Its programming software is very easy to use. Among its various and user-friendly functions, the function "SIMULATION" which allows to check the program before using it in real condition.

Dimensions of the box: 360 x 270 x 170mm

Sum up of functions and possibilities of the unit and its software:

- 12 inputs 24V DC, 6 can be wired in analog inputs 0-10V
- 8 dry contacts outputs
- a display indicating state and local programming
- 6 keys for local programming

MODEL WITH TCP-IP ETHERNET MODULE



ref. ZELIO-NET



We have added to the ZELIO-201-24 (opposite) a network communication module which can be used to connect the ZELIO to the Ethernet using the Modbus TCP protocole

Ethernet module features:

- direct connection to the ZELIO
- female RJ45 reinforced cable
- a communication display LED (LK/ACT 10/100)
- a STATUS display LED (STS)

SOFTWARE SUPPLIED WITH ZELIO-201-24 AND ZELIO-NET

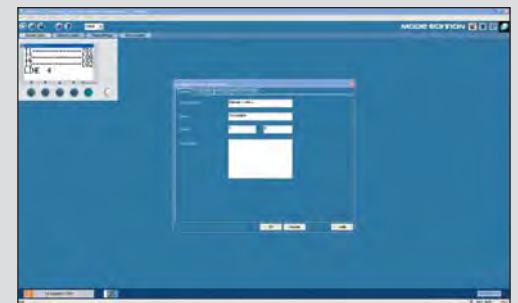
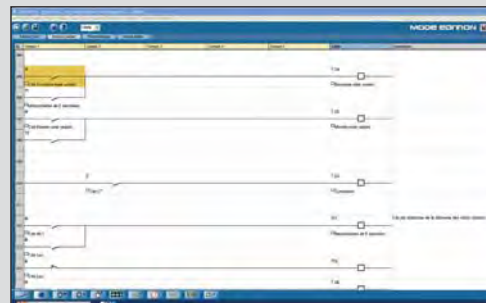

The multilanguage software also has :

- 3 programming languages
- a good viewing of clock settings
- a free keyboarding of associated comments for the follow up of steps.
- a simplified communication between the unit and the PC (serial connection)
- a direct display of the text on the unit display
- a visualization of outputs state
- an input/output computer simulation by a simple click on the mouse.

Help function for user

Besides its help function always available as a Search Menu, the software has a demo video functioning like a VCR. Short films show the main steps for programming the system.

Simulator for checking controller (PLC) programming



ref. PUP-PLC

Checking a PLC program requires the connection of an operative part. PUP-PLC groups together a set of actuators, power supplies and components required for checking programs. Its complete composition provides great comfort for this check.



Features

- 3-metre mains lead for power supply 230V-50/60Hz single phase.
- Console dimensions: 1000 x 160 x h 300mm. Weight: 14kg.

Composition of the console

- 1 Start / Stop button with indicator light (general control)
- 1 magneto-thermal + RC circuit-breaker 30mA
- 3 pushbuttons NO
- 3 pushbuttons
- 2 ON/OFF switches NO
- 2 ON/OFF switches
- 1 wind sensor, binary contact
- 1 light sensor, binary contact
- 3 limit switches NO
- 1 Temperature sensor PT100, 3-wire output
- 1 voltage generator adjustable by potentiometer from 0 to 10VDC

- 1 current generator adjustable by potentiometer from 4 to 20mA
- 1 dimmer 230VAC with control 0-10VDC
- 1 dimmer 230VAC with control 4-20mA
- 1 buzzer 24VDC
- 2 3-pole contactors 24VAC + 2 auxiliary contacts NO
- 3 green indicator lights 24VAC
- 3 red indicator lights 24VAC
- 1 source of fixed voltage 230VAC 50Hz
- 1 source of fixed voltage 24VDC
- 1 source of voltage 24VAC 50Hz
- 1 carrying handle

Quality control system by vision sensor

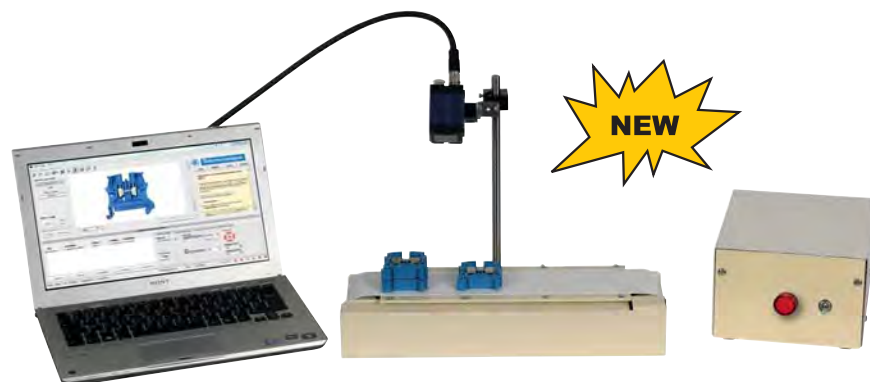

ref. MAQ-VISION



EDUCATIONAL OBJECTIVES

- Study and putting into service of a quality control system by vision sensor
- Creating the wiring for motorized conveyor belt and video and position sensors
- Using video recognition programming software

TEACHING RESOURCES STUDENT & TEACHER

Practical works proposed

- Carry out the configuration and programming of the video sensor using the software
- Creation of the wiring diagram
- Wiring of the conveyor belt, vision sensor and position sensor
- Testing with different part samples

Composition of the model

- Power supply unit, magneto-thermal protection device and indicator light.
- Motorized conveyor belt 24VDC.
- Colour vision sensor on height and tilt adjustable support.
- Binary position sensor.
- Indicator light for "nonconform part".
- 1 Configuration software.
- 2 part samples, conform and nonconform.

MAQ-VISION is a model equipped with a vision sensor combined with configuration software for part surveillance and recognition by video. This type of automatic visual quality control is nowadays used on many production lines. It enables the checking of parameters like presence, position, orientation, sorting, integrity and marking. It is also used for guiding before gripping. The image of the reference part and its acceptance tolerances are saved in the sensor's memory. The "good part" or "bad part" result is obtained from "binary" outputs.

MAQ-VISION is equipped with a motorized conveyor belt 24VDC. It carries the part under the sensor for checking. An indicator light signals if the part is conform or not.

Supplied with the video recognition programming software.

Features

- 2-metre mains lead for power supply.
- Dimensions of the housing: 240 x 180 x h 130mm.
- Dimensions of the conveyor belt: 300 x 110 x 120mm.

Managing of hypermarket lighting by supervision

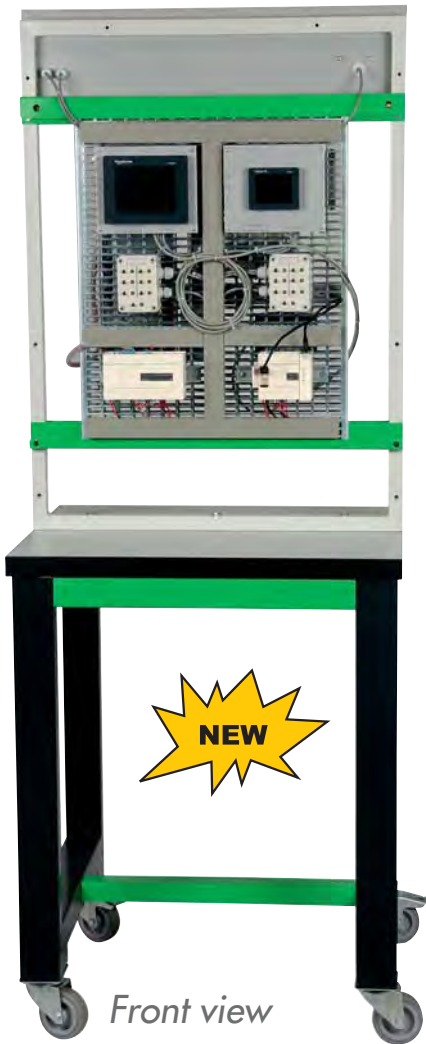

Front view



Rear view

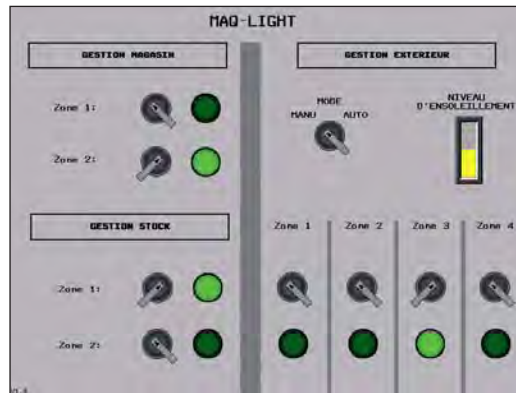

ref. MAQ-LIGHT

Large floor area buildings, like supermarkets, require a lot of lighting. The control of this lighting is a real economic and ecological issue which requires thinking about the concept of zoning and presence. MAQ-LIGHT offers the study of this need through controllers (PLC) and supervision controlled by 2 touch screens.

The presentation with two-sided vertical panels on a wheeled frame provides an ergonomic view of the zones to be controlled.

Comprises

- 1 unit with magneto-thermal, RC protection devices & emergency stop.
- 3 SCHNEIDER® Ethernet PLCs
- 1 Ethernet colour touch screen HMIS5T 3.5"
- 1 Ethernet colour touch screen HMIS5T 5.7"
- 1 presence detector
- 1 Day / Night simulation unit with potentiometer
- 1 engraved face defining the 3 lighting zones
Face equipped with 16 indicator lights simulating the light points
- 3 control units with 7 pushbuttons and 7 indicator lights
- 1 Ethernet RJ45 switch
- 6 Ethernet leads, 1.5 metres

EDUCATIONAL OBJECTIVES

- Study and putting into service of a lighting management system for hypermarket by supervision
- Studying the configuration of an Ethernet type computer network
- Studying the programming of a PLC in contact language
- Studying the programming of an HMI (Human Machine Interface)
- Studying the coexistence of several PLCs and HMIs

TEACHING RESOURCES STUDENT & TEACHER

Practical works

- Creation of the architectural diagram of the electrical installation
- Creation of the computer Ethernet
- Creation of PLC programs in contact language
- Creation of the supervision from the two touch screens
- Change of IP addressing
- Testing the assembly

Features of the unit

- Power supply 230VAC by 3-metre mains cord
- Dimensions: 750 x 670 x h 1950mm
- Weight: 64 kg

Ventilation control and tunnel access

Features of the unit

- Wheeled frame 750x670mm
- Total height: 1870mm
- Powered by a 400V three-phase hypra socket
- 1000VA Fan, 96m³/min maximum flow rate, 400V 3-phase, Ø 400mm.



ref. TA11

EDUCATIONAL OBJECTIVES

- Studying, putting into service, getting started and setting of the system
- Understand the setting and the programming by PLC
- Understanding and use of a supervision
- Practical approach of analog inputs

USER'S MANUAL + TUTORIALS + MONITORING

Proposed Practical Works

- PLC programming
- Loading, modification, creation of a supervision program
- Ethernet network configuration
- Analysis of the regulation

TA11 is a study system used to regulate the CO₂ level in a motorway tunnel. It consists of a fan for air renewal and an electrical cabinet grouping the regulation system components. The cabinet and fan are placed on a wheeled frame and connected by a 5m cable.

Complete unit supplied ready for operation with monitoring. The PLC is supplied as well as the monitoring program and wiring diagrams.

Are also supplied: The Teachers/Students tutorials on PLC programming, monitoring, the Ethernet network, analogue regulation.

Operation

On the cabinet's door, a potentiometer simulates the CO₂ level in the tunnel. Depending on the CO₂ level, the PLC controls the fan's rotation speed and plans the access to the 4 traffic lanes represented by 8 indicator lights positioned above the cabinet. A stand-alone fire sensor indicates there is a fire in the tunnel. An electronic buzzer warns that the CO₂ level is too high. An anemometer fixed in the fan's air flow controls the rotation. This regulation system is PC monitored via the Schneider® software supplied.

The main cabinet components

- 1 Schneider® PLC
- 1 2.2kW speed controller
- 1 analogue card controls the 4-20mA or 0-10V speed controller signal.
- 1 Ethernet card is used to connect the entire system to an IP computing network such as, for example, the establishment's network to monitor operations from a remote computing room.
- Controls on the front of the door:
 - General Start/Stop button
 - Emergency stop
 - CO₂ level potentiometer
 - Auto/Manual
 - Fan Start/Stop button
 - Potentiometer for the fan air flow
 - Warning buzzer if excessive CO₂ level
 - RJ45 connector for the PC link
 - Electrical protective devices for users and equipment.

Monitoring software program

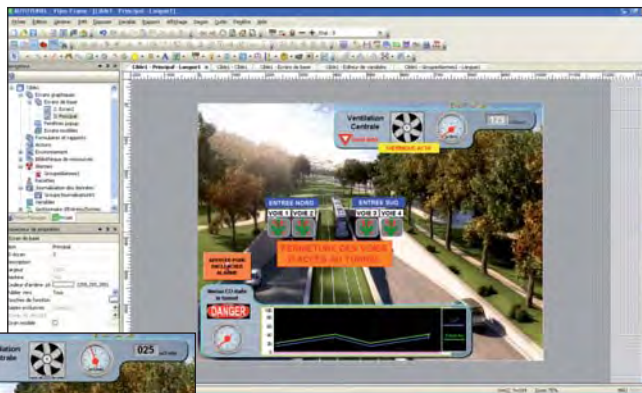

Monitoring from a PC



PLC program

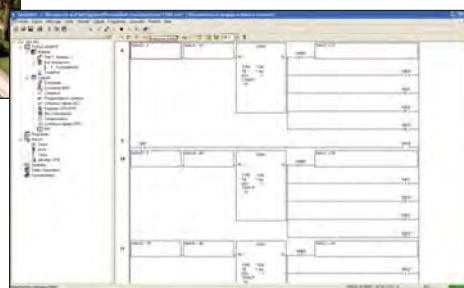

Programming systems (with USB connection)

LIGHTING CONTROL SYSTEM WITH PLC



ref. COFEC
these different equipments can be sold separately



This model is a room lighting unit comprising an electrical cabinet and a console fitted with low-voltage spotlights. Using a TCP/IP PLC and monitoring software, it is possible to control the model and view its operation on a computer.

OPERATING PART: ELECTRICAL CABINET + LIGHTING CONSOLE

- 1 32A rated 30mA residual current four-pole circuit breaker
- 2 double pole circuit breakers for protecting the 6 lighting circuits
- 6 double pole remote control switches.
- 1 double pole circuit breaker for protecting the PLC.
- 1 connection terminal block
- 6 24V LED lamps
- 6 push-buttons for manual lighting control
- 1 3m multiwire cable for connecting the lights to the electrical cabinet.

PLC

- with 10 relay outputs and 14 inputs, supplied with
 - a cable for interconnection with the model
 - programming software in English/French in ladder language.
- Dimensions: 170 x 130 x 130 mm. 220-240V AC

MONITORING

- Allows you to manage the lighting control model from a PC
- Offers the basic features of a graphical tool
 - acquisition and display of PLC variables
 - monitoring and control of lights (switching on, switching off and timer)
- The software's graphics editor supports many applications.

The user can modify the preloaded demo program or create a new one

FEATURES OF THE ASSEMBLY

- Powered by a 230V mains cable
- Metal industrial cabinet with a glazed door. Dims: 400 x 300 x 200 mm
- Lighting console: dim. 400 x 330 x 200mm
- The assembly is supplied already wired with a monitoring example and all mains leads necessary for proper operation

TRAFFIC LIGHTS WITH PLC



ref. TRICAUTO
these different equipments can be sold separately

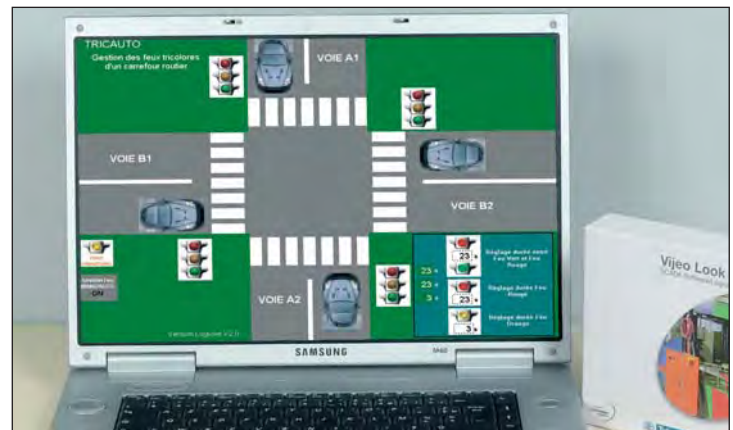

This model simulates a crossroad equipped with 4 traffic lights. Using a TCP/IP PLC and monitoring software, it is possible to control the model and view its operation on a computer.

OPERATIVE PART

- 6 x traffic lights control INPUT by 24 VDC level
- 4 x car detection sensor OUTPUT by 24 VDC level (supplied by the PLC)
- 6 x traffic lights manual switch on/off
- Interconnection : DB25 plug
- Dimensions : 390 x 325 x 140 mm

PLC (PC connection via USB)

- model : 9 output & 7 relay inputs, supplied with :
 - one interconnection wire plug link on the didactical model.
 - one programming software (english/french) based on "contact" language.
- Dimensions : 170 x 130 x 130 mm / 230-240 VAC

MONITORING

- Traffic lights system controlled from a computer
- Visual and intuitive display interface :
 - Acquisition of PLC parameters and visual control
 - Cars and traffic lights monitoring
 - Traffic lights control (switch on/off adjustment time, orange flashing)
- The software visual editor allowed to adapt the basic settings and to change software visual interface. Large possibility of use according to your particular teaching needs.

FEATURES OF THE ASSEMBLY

- Dim. 390 x 325 x 160mm
- The assembly is supplied already wired with a monitoring example and all mains leads necessary for proper operation

LIGHT SIGNS SYSTEM (FOR A MOTORWAY TOLL)

ref. AUTO-PEAG
these different equipments can be sold separately

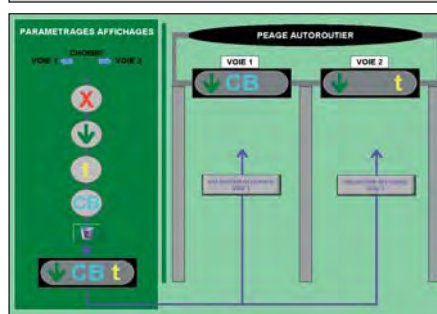

Simulates a motorway toll. Comprises 1 electrical cabinet and 2 toll lane indication signs. Using a TCP/IP PLC and monitoring software, it is possible to control the model and view its operation on a computer : opening/closure of lanes, management of banker's card or telepayment (electronic road pricing (ERP)) payments, manual or automatic function with time-stamp on the PLC, etc.

ELECTRICAL CABINET

- 1 32A rated 30mA residual current four-pole circuit breaker
- 1 bipolar circuit breaker for protecting the PLC and sign
- 1 set of junction boxes

OPERATING PART, EACH CONSISTING OF

- 4 24V lamps (Open / Closed / Banker's card / Telepayment)
- 2 m of multiwire cable for connecting to the electrical cabinet.

PLC (PC connection by USB)

- with 10 relay outputs and 14 inputs, supplied with
 - 1 TCP/IP interface for Ethernet connection
 - 2 1.5m multiwire cables for interconnection with the model
 - programming software in English/French in ladder language.
- Dimensions: 170 x 130 x 130 mm. 230-240VAC

MONITORING

- Multilingual programming software for managing the toll indication cabinet from a PC.
- Offers the basic features of a graphical tool
 - acquisition and display of PLC variables
 - monitoring and control of the toll lane (lane open, lane closed, payment by BC or telepayment)
- The software's graphics editor supports many applications.
The user can modify the preloaded demo program or create a new one

FEATURES OF THE ASSEMBLY

- Powered by a 230V mains cable
- Metal industrial cabinet with a glazed door
Dimensions: 400 x 300 x 200 mm
- Indication sign: 420 x 80 x 70 mm
- The unit is supplied already wired with an example of monitoring and all the linking cables which are required for its proper operation

PUMPING STATION

ref. CHATO-SIM
these different equipments can be sold separately

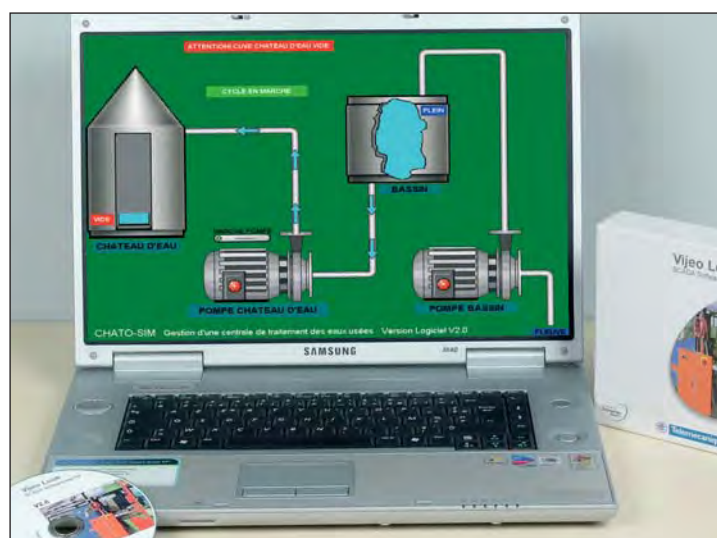

This model simulates a drinking water pumping station. Using a TCP/IP PLC and monitoring software, it is possible to control the model and view its operation on a computer.

OPERATING PART

- 3 push-buttons for On / Cycle Start / Cycle Stop
- 6 switches representing the water level sensors.
- 4 lamps representing the operation of the two pumps.

PLC (PC connection by USB)

- with 7 relay outputs and 9 inputs, supplied with
 - a TCP/IP interface for the Ethernet connection
 - a 1.5m M/F DB25 cable for interconnection with the model.
 - programming software in English/French in ladder language.
- Dimensions: 170 x 130 x 130 mm. 230-240V AC

MONITORING

- Multilingual software for controlling the lights using a PC
- Offers the basic features of a graphical tool
 - acquisition and display of PLC variables
 - monitoring and control of the station' operation (start-up and shutdown of the pumps and maintenance operations, etc.).)
- The software's graphics editor supports many applications.
The user can modify the preloaded demo program or create a new one

FEATURES OF THE ASSEMBLY

- Dimensions: 330 x 200 x 80mm
- The assembly is supplied already wired with a monitoring example and all mains leads necessary for proper operation

System for water level & flow regulation by PID



Terminal block with inputs and outputs of variator control and PID sensors

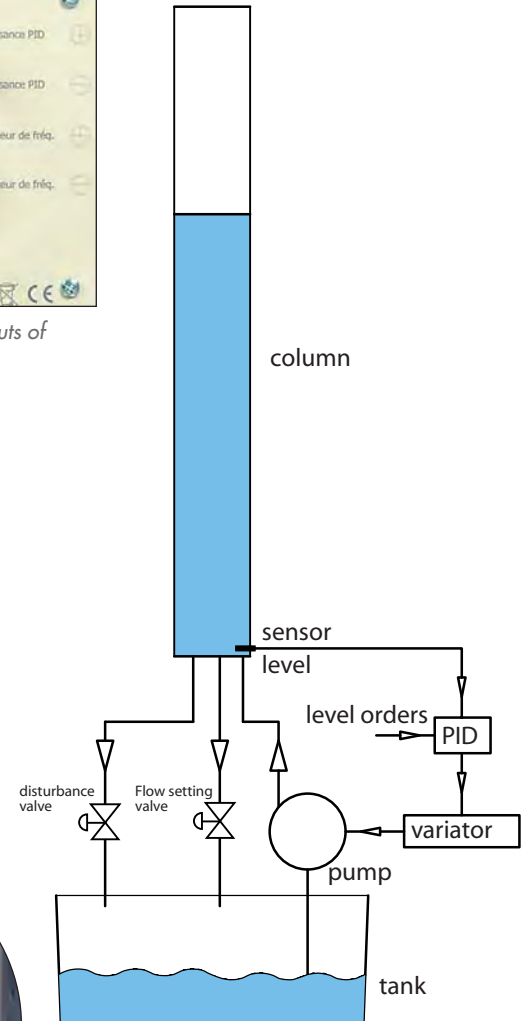

- Power supply : 230VAC
- Overall dimensions: 1100 x 670mm Height: 1980mm. Weight 104kg.

ref. DESNIV

OPERATING PRINCIPLE

The objective is to adjust the water-level in a transparent polycarbonate column –diameter 160mm, height 1370mm. A pump draws the water from a 50-litre tank at the bottom of the column. The water constantly flows through the setting valve from the column towards the tank under gravity.

The PID regulator receives the “water-level” information from a 4-20mA sensor. It compares this signal with the level reference and controls the pump delivery via a frequency variator.

The system operates in two modes: servo control and regulation. In regulation mode, a manual valve creates the disturbance.

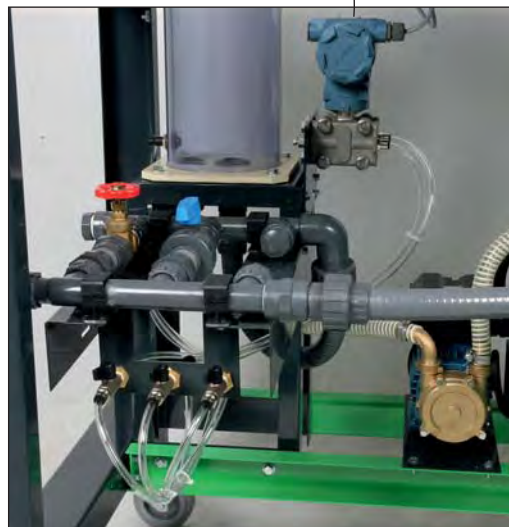

Pressure sensor and disturbance valves

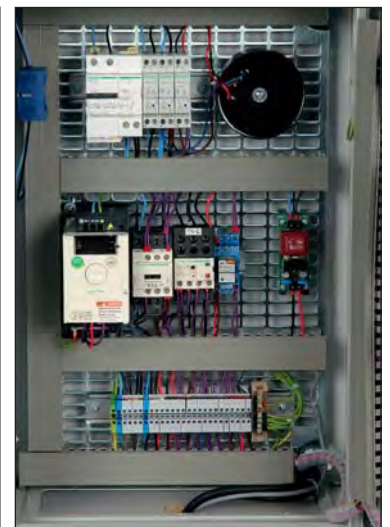

Wired grid including with a speed controller

EDUCATIONAL OBJECTIVES

- Studying, putting into service, getting started and setting of the system
- Understanding and setting of the PID level regulation
- Calculating the span & zero offset of a level measurement by hydrostatic pressure of wet column. Adjust the level transmitter
- Wiring, putting into service & adjustment of components: transmitter, regulator ...
- Make current measurements as in industry, without opening loops, with the help of a multimeter.
- Taking in hand the setting software of the frequency converter.

TEACHING RESOURCES – 19 PRACTICAL WORKS

PRACTICAL WORKS ON THE MEASURING CIRCUIT

- Wiring the measuring loop which comprises the 4-20mA output differential pressure transmitter, a 24V DC power supply and the PID.
- Calibrating the level transmitter Dry column method.
- Calibrating the level transmitter Wet column method.
- Producing a calibration sheet for the transmitter, and a calibration curve.
- Calculating the scale range of the transmitter.
- Measuring the current in the loop, without opening it.
- Using a calibrator for measuring the transmitter current or generating a 4-20mA current on the PID input.

PRACTICAL WORKS OF REGULATION

- Producing a regulation loop diagram, with a view to wiring the correction component and the measuring circuit
- Producing an operating diagram through the identification of various components, namely: the regulator, the correction component and the process.
- Identifying the quantities at play, namely: the adjusted quantity, controlled variable, correcting variable and disturbances
- Determining the direction of the regulator depending on the direction of the process and the correction component
- Determining the static features of the procedure, with a view to calculating the following adjustments: integration constant, dead time
- Implementing various empirical methods for setting PID correctors
- Testing the performance of the loop, in servo-control mode and in regulation mode
- Displaying on a flatbed plotter or PC, or by manual measuring, the responses of the PID adjusters, by requesting the measurement input by position or speed level
- Implementing and verifying a level measurement for a dry column or a wet column

DESIGN

The DESNIV model uses only industrial components.

- A PID regulator – 4-20mA standard on the measuring input and on the output.
- An industrial three-phase pump, with a bronze body
- A differential pressure level sensor
- An industrial frequency variator

The column is large in size, as is the volume of water it contains. Therefore, it has high inertia. This means that the physical phenomena are very similar to those for high-capacity tanks used by the pharmaceutical and oil industries. Pressure differences due to the significant height of the water column can be used to adjust the water-level to the nearest 5mm.

The inputs and outputs for the following are grouped together on a terminal block which is separate from the electrical cabinet: sensor, regulator, variable speed drive and 24V DC power supply. Students wire up the control and measuring loops on this terminal block. They cannot come into contact with dangerous voltages, as these are confined to the electrical cabinet. The maximum voltage that can be accessed on the student terminal block is 24V DC.

The terminal block and the components allow all wiring errors and fault finding exercises. The “water-level” and “pump delivery” curve charts (curve charts used to determine the static gain, loop gain and critical gain, the dead time and the time constant) are noted either manually (the slow speed of the phenomena means that this procedure is possible), or using a PC combined with LOGINIV software (option) and the associated interface, or by using general software.

The DESNIV model does not need to be connected to the water network. In order to prevent any overflow, a binary level sensor stops the pump if the water rises up to the top section of the column.

SUPPLIED WITH A 4-20MA LOOP CALIBRATOR



- Programming in % of the output span to supply a typical intensity like 4 – 8 – 12 – 16 or 20mA
- linear ramps, manual ramps, auto ramps
- Display: 5 digits
- Carry case, user's manual, external battery Pack (for 6x 1.5V AA batteries)
- Input for mains adapter DC 12V (not included)
- Dimensions : 88x168x26mm Weight : 330g

RANGE	RESOLUTION	ACCURACY
4 - 20 mA	1 μ A	0.025% + 5 μ A
0 - 20mA	1 μ A	0.025% + 5 μ A
0 - 24mA	1 μ A	0.025% + 10 μ A
4 - 20V	1mV	0.05% + 5mV
0 - 20V	1mV	0.05% + 5mV
0 - 24V	1mV	0.05% + 10mV

LOGINIV INTERFACE & SOFTWARE (OPTION)

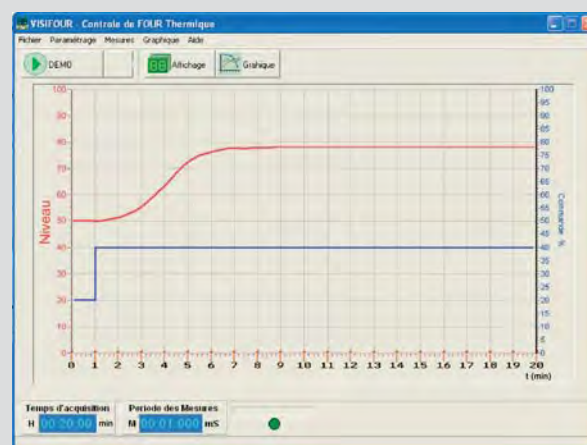

ref. LOGINIV

This PC interface – connected to the DB9 outlet – and software are used to record and draw graphs of instantaneous water level and control signal of the pump speed directly on PC. The connection to PC is made by USB.

Additional functions

- Numerical display of the two measurements
- Cursor function
- Compilation of data in a spreadsheet
- Zoom function

Level control system by means of PLC & touchscreen

EDUCATIONAL OBJECTIVES

- Studying, putting into service, getting started and setting of the system
- Understanding the setting and the programming by PLC
- Understanding the PID level regulation, probes and sensors

TEACHING RESOURCES - PRACTICAL WORKS

Practical works

- Drawing of wiring diagrams
- Setting and programming the PLC
- Configuration of the PC Ethernet links / PLC / Touch Screen
- Configuration and setting of the touch screen
- Setting the 4-20mA water level regulation with the PID of the programmable PLC
- Wiring the grid
- Understanding the functioning of the level regulation by PID, probes and sensors

REGULEAU is a level control system relying on a PLC and touchscreen, which can be used in three detection modes, using

- 3 binary floats
- 4 height-adjustable conductive probes
- 1 4-20mA hydrostatic pressure sensor

The water drawn from the lower tank supplies the upper tank (where the sensors are located) before running away via a manual valve.

The PLC's PID and the variable flow pump allow a level control.

COMPONENTS PARTS OF THE MODEL

- 1 100L lower tank
- 1 transparent 60L upper tank, graduated in cm
- 3 level sensors with binary float (24V-3A).
- 4 50cm long Ø 6mm conductive probes.
- 1 hydrostatic pressure sensor.
Rating: 4-20mA output for 0-600mm water level
- Cabinet and console
- 1 5.7" TFT touchscreen
- 1 4-port RJ45 Ethernet hub
- 1 three-phase speed controller
- 1 PLC with software, fitted with a TCP/IP interface for the RJ45 link to a PC and the touchscreen.
14 Inputs + 10 Binary Outputs (24V)
1 analog input 4-20mA
1 analog output 4-20mA and 0-10V
- 1 Vijeo Designer® software with a complete monitoring program
- 1 30mA residual current circuit breaker. thermal-magnetic circuit breakers
- 230V power supply
- Base with wheels + brake. 1500 x 750mm - Weight 144kg

ACTION OF THE MONITORING

- starting and stopping the system
- choice of level control type
- water level and settings bargraphs
- display and adjustment of the PID parameters
- display of the speed controller's power in correlation with the pump delivery
- adjusting the settings



Example of monitoring on the touchscreen



ref. REGULEAU

REGULEAU IS SUPPLIED ALREADY WIRED AND READY FOR USE WITH TUTORIALS, INSTRUCTIONS, SOFTWARE PLC AND MONITORING PROGRAMS.



Removable grid quickly taken through Harting ® plugs.

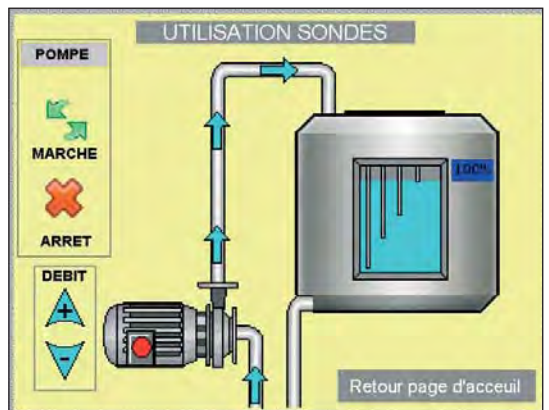
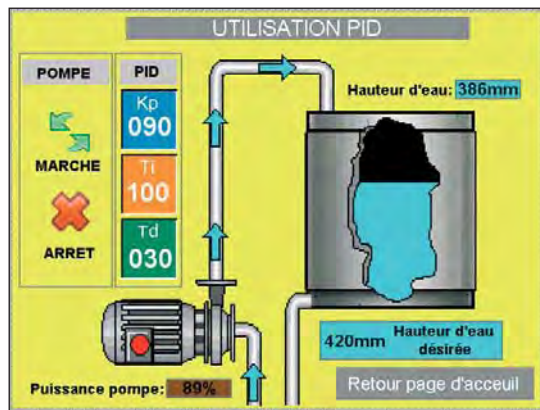
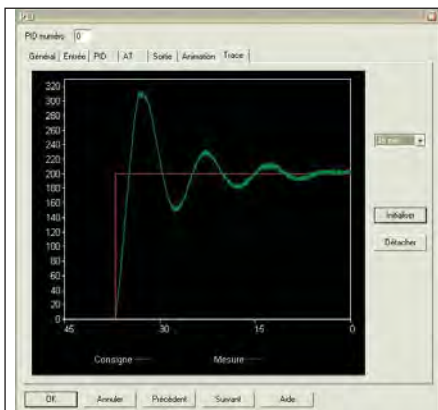
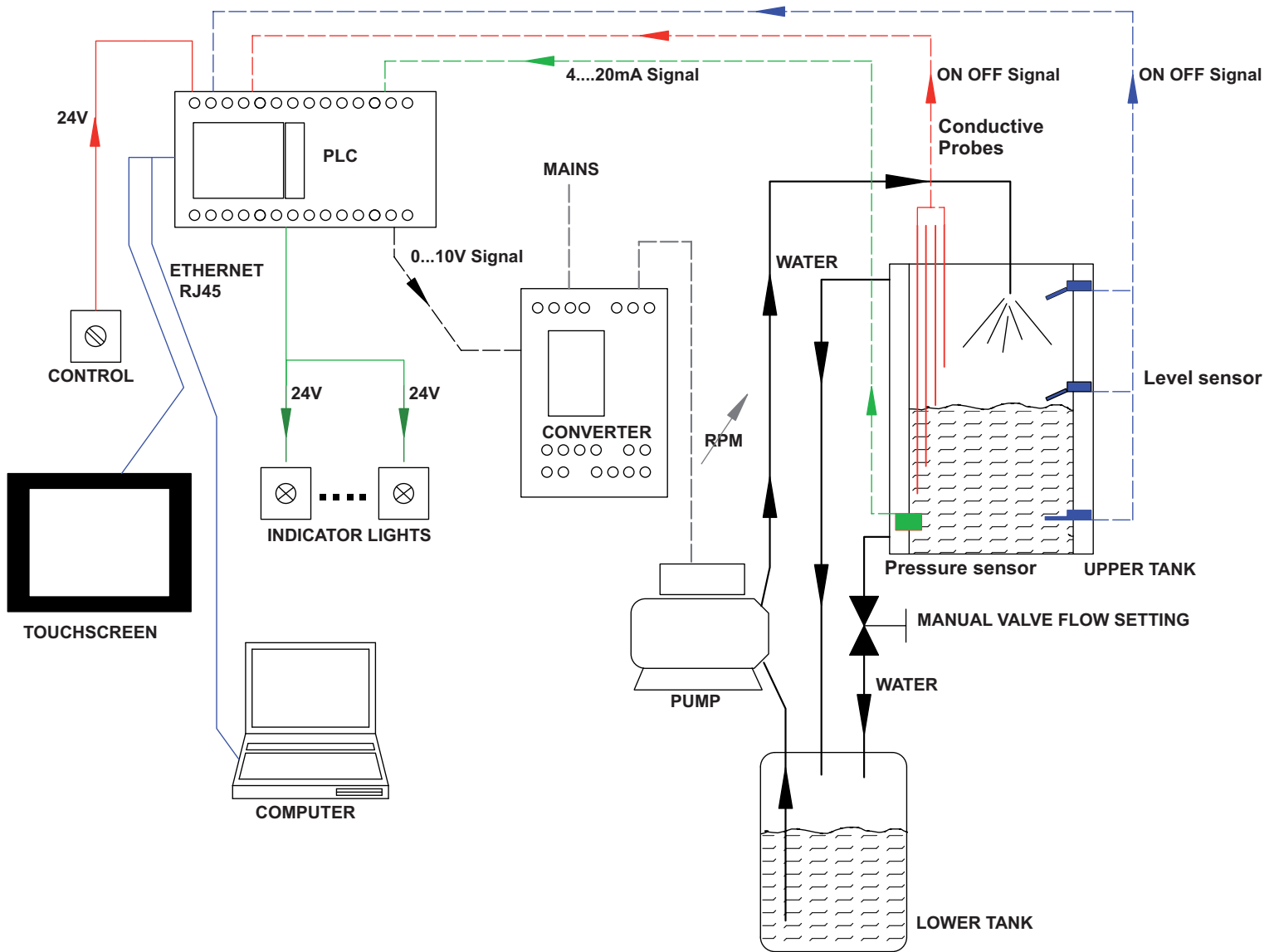

All or nothing temperature regulation

EDUCATIONAL OBJECTIVES

- Understanding and wiring of a regulation chain All-Or-Nothing.
- Studying, setting, control of a All-Or-Nothing regulator.
- Retrieving information by computer (communicating version).
- Understanding of the link resistance / temperature as measuring principle.

USER'S MANUAL & THEORETICAL COURSES

Set of components for the study of a All or Nothing temperature regulation loop with a PT100 temperature sensor and 4-20mA signal.

These solutions of regulation are delivered with all the necessary safety leads, a user's manual for each component and also wiring diagrams.

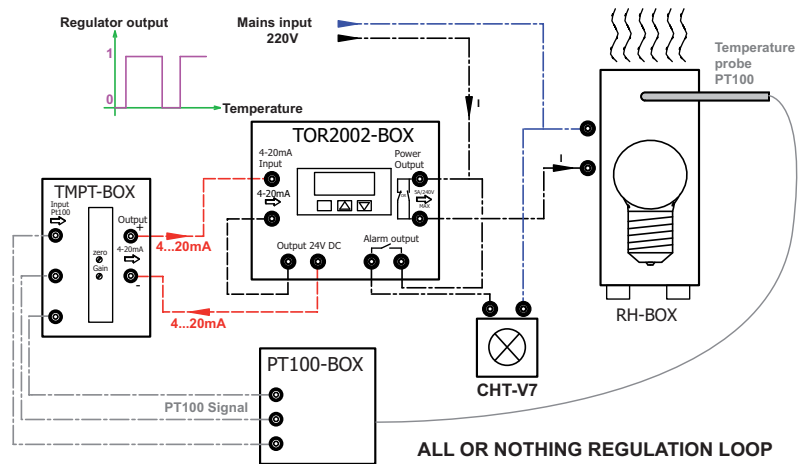

ref. REGULOR standard model

ref. REGUL-S communicating model

MAIN COMPONENT - STANDARD VERSION

MAIN COMPONENT - COMMUNICATING VERSION

REGULATOR TOR
Ref. TOR2002-BOX
See Page 188



COMMUNICATING
REGULATOR TOR
Ref. TOR-COM
See Page 188

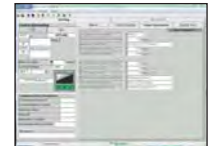

COMPONENTS COMMON TO THE BOTH REFERENCES



HEATING UNIT
Ref. RH-BOX
See page 187



PT100 TEMPERATURE
CONVERTER
Ref. TMPT-BOX
See page 187



LIGHT
Ref. CHT-V7
see page 55



PT100 TEMPERATURE SENSOR
Ref. PT100-BOX
See Page 187

PID temperature regulation

EDUCATIONAL OBJECTIVES

- Understanding and wiring of a regulation chain of temperature by PID
- Studying, setting, control of a PID regulator
- Retrieving information by computer (communicating version).
- Understanding of the link resistance / temperature as measuring principle.

USER'S MANUAL & THEORETICAL COURSES

Set of components for the study of a 4-20mA temperature regulation loop with a PT100 temperature sensor and a dimmer switch, all controlled by PID regulator.

These solutions of regulation are delivered with all the necessary safety leads, a user's manual for each component and also wiring diagrams.

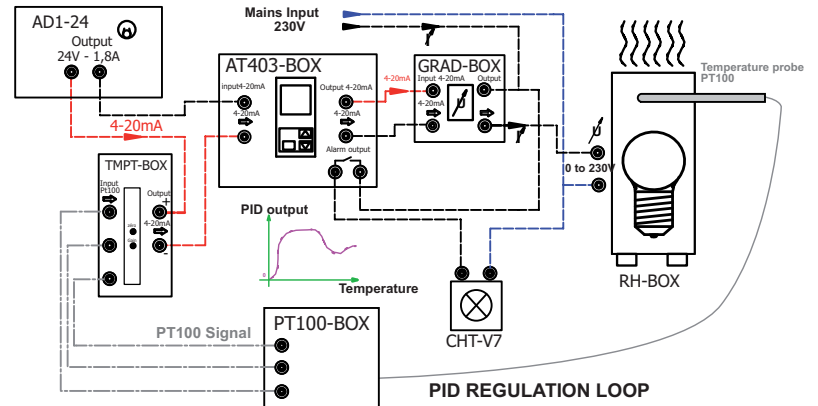

ref. REGULIDE standard model

MAIN COMPONENT - STANDARD VERSION

PID REGULATOR
Réf. AT403-BOX
Voir page 189



ref. REGUL-G communicating model

MAIN COMPONENT - COMMUNICATING VERSION

COMMUNICATING
PID REGULATOR
Réf. PID-G
See Page 189



COMPONENTS COMMON TO THE BOTH REFERENCES



HEATING UNIT
Ref. RH-BOX
See page 187

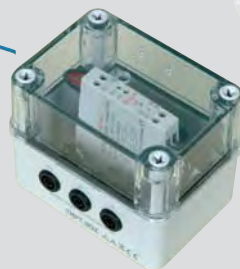

PT100 TEMPERATURE
CONVERTER
Ref. TMPT-BOX
See page 187



LIGHT
Ref. CHT-V7
see page 55



PT100 TEMPERATURE SENSOR
Ref. PT100-BOX
See Page 187



DC POWER SUPPLY
Ref. AD1-24
See page 189



SCR POWER CONTROL
Ref. GRAD-BOX
See Page 187

Temperature control by PLC

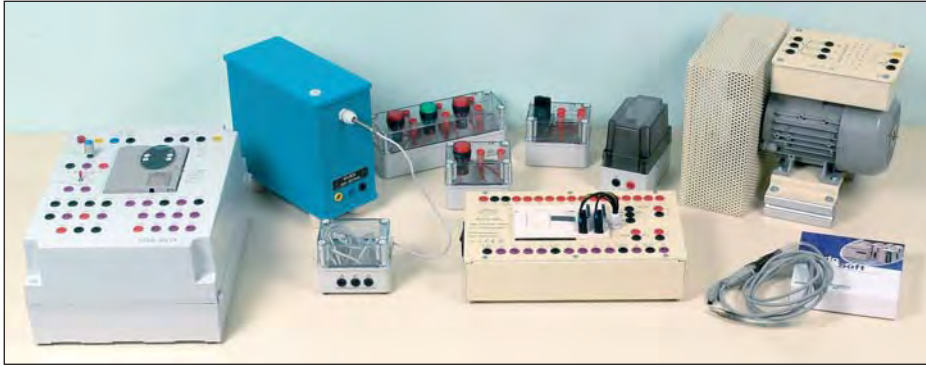

ref. REGULAIR

EDUCATIONAL OBJECTIVES

- Studying the analogical regulation loop
- Studying the role of the frequency converter in a regulation system
- Understanding the PID configuration by PLC

USER'S MANUAL + PRACTICAL WORK

Practical works

TUTORIAL-1 STUDY OF THE 0-10V CONTROL

TUTORIAL-2 STUDY OF THE 4-20mA CONTROL

TUTORIAL-3 STUDY OF THE TEMPERATURE REGULATION BY PID

SUPPLIED READY FOR OPERATION WITH THE TECHNICAL INSTRUCTIONS, THE PROGRAMMING SOFTWARE AND THE PLC PROGRAMS WHICH CORRESPOND TO THE VARIOUS TUTORIALS TO BE UNDERTAKEN. ALL OF THE COMPONENTS CAN BE SOLD SEPARATELY.

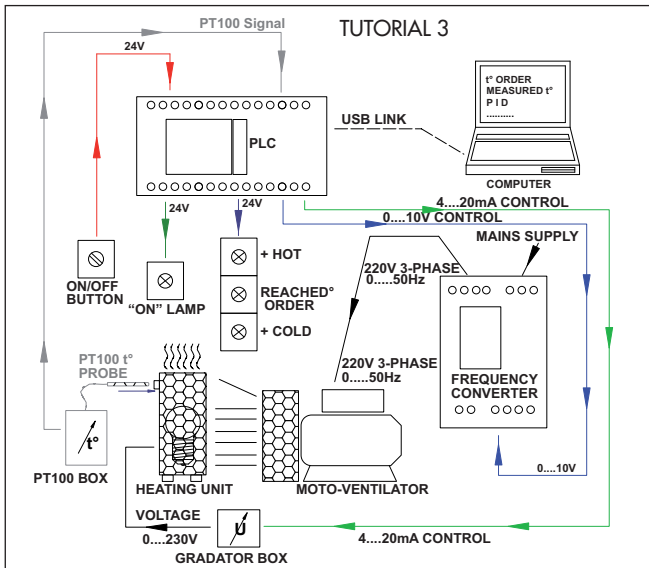

For each tutorial, students must:

- Develop the PLC program
- Configure the speed controller (tutorial-1 and tutorial-3)
- Produce the wiring diagram
- Wire the components
- Modify and observe the speed settings (tutorial-1), temperature settings (tutorial-2) and PID settings in order to regulate the temperature around a setting (tutorial-3)
- Using the PLC, measure on the PC the setting and instantaneous temperature curves (tutorial-3)

PID function from the PLC. The values of the settings, temperature, power output and the proportional and derived coefficients are completely configurable.

COMPONENTS OF THE REGULAIR SYSTEM

Moto ventilator

230/400V 3-phase asynchronous motor
Rated speed 1500 RPM
Power supply on safety sockets 4mm



Electric fan shown without its protection cover

• SCR power unit

Single-phase SCR power unit
Connection by means of safety leads
4-20mA control
1 max. output: 15A
Dim: 100 x 80 x 90mm

• Heating unit

230V mains power supply by means of safety terminals
75W lamp
Max. heating temperature of approximately 90°C
Can accommodate temperature probes up to 7mm in Ø

• Pt100 box

Pt100 Temperature Probe – 3 wires
Connection by means of safety leads
Cable length: 90cm
Dim: 10x 80 x 90mm

• PLC Unit

14 inputs (24V)
10 binary outputs
1 Pt100 analogue input
2 outputs 0...10V and 4...20mA
Mains power supply by means of socket unit + switch
PLC programming software

• Speed variator (frequency converter)

230V mains input
Output to 230V three-phase motor
1 input 0...10V
Protection against short circuits
Protection against overloads
Protection against phase outages
Connection by means of safety terminals

• Control units + lamps

1 2-position switch
4 24V lamps (3Red + 1Green)
Connection by means of safety leads
2 outputs 0...10V or 4...20mA
Mains power supply by means of socket unit + switch

SRC power control and loads for regulation

HEATING UNIT

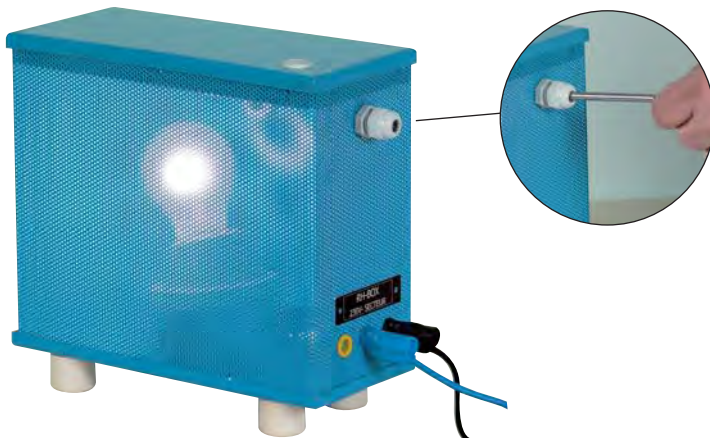

ref. RH-BOX

230V power supply heating unit fitted with a 75W lamp. Completely safe thanks to two 4mm double channel terminals. The Pt100 temperature probe, with a maximum diameter of 7mm, can be inserted sideways (e.g. PT100-BOX). Powered via 230V mains supply or SCR power unit (e.g. GRAD-BOX), which regulates the light intensity and therefore the temperature in the unit. This temperature can be measured by a temperature probe (e.g. PT100-BOX)

Features

- 75W incandescent lamp – E27
- Mains power supply via 2 safety terminals
- Inlet port can accommodate temperature probe up to 7mm in Ø maximum
- Dim: 250 x 250 x 110mm

PT100 TEMPERATURE SENSOR

FEATURES

- Connection by means of safety leads.
- Dim: 100 x 80 x 90mm
- Cable length: 90cm

ref. PT100-BOX

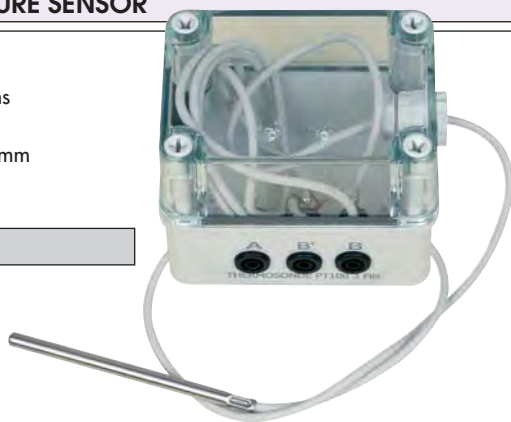

SINGLE-PHASE SCR POWER CONTROL

Controls the power in the charge by varying the conduction angle of the thyristors according to the control current of 4-20mA. Can be connected directly to the built-in PLC unit ref. AUTO-BOX-A.

FEATURES

- Connection by means of safety leads.
- Max. current output: 15A
- Dim: 100 x 80 x 90mm

ref. GRAD-BOX



SCR POWER CONTROLS

These SCR power units control the power in the charge by varying the conduction time of the thyristors according to the control current 4 – 20mA

The power, the output power, the control input 4-20mA and the potentiometer can be used on 4mm safety terminals.

A potentiometer front allows to vary the conduction time.

Compatible with resistive loads only.



Ref.	CIA-GRA30M	CIA-GRA30T
Supply type	Single-phase	3-phase
Main supply	230VAC	3 x 400VAC
Auxiliary supply	-	220VAC from mains (for the cooling fan)
Output voltage	230VAC	3 x 400VAC
Max. output current	30A	30A
Control	4-20mA and/or potentiometer	4-20mA and/or potentiometer
Dimensions	290 x 190mm x 135mm	390 x 280mm x 185mm

PT100 - 4-20mA TEMPERATURE CONVERTER

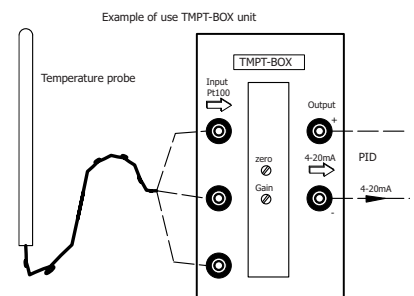

- This unit allows the connection of a temperature probe to the 4-20mA input of the PID.
- Adjustment of the signal gain & zero thanks 2 potentiometers
- Compatibility with the 2 or 3 wires temperature probes (see PT100-BOX)
- Input/output connection on safety sockets 4mm
- Works without any external supply
- DIMS: 77 x 106 x 92 mm

ref. TMPT-BOX

All-or-nothing regulators for regulation

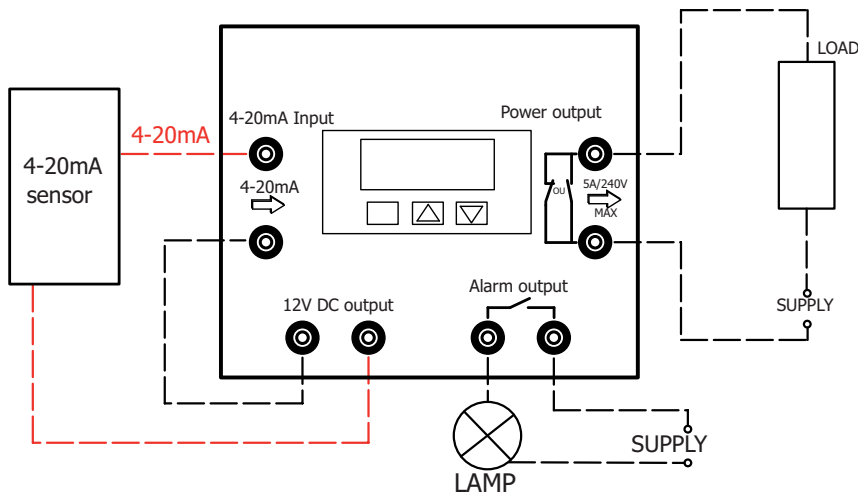

The regulator unit controls in all-or-nothing the supply of the load from a 4-20mA signal.

EXAMPLES OF USE Enter the order value directly in the regulator. When the 4-20mA signal from the sensor reaches the order value, the state of the dry contact changes and opens (or closes) the supply circuit of the load (programming of the contact state: NO or NC). Supply of the unit in 230V (power cord)

The communicating version has the same features and includes in addition a possible programming by software and retrieving datas (files + curves).

STANDARD MODEL



ref. TOR2002-BOX

- 4-20mA input on safety sockets 4mm
- 10 000 counts configurable display
- Settings of the display :
 - For 4mA input, the user can choose the value displayed between -1000 and 9999
 - For 20mA input, the user can choose the value displayed between 0 and 9999.
- Setting of the decimal point
- Example of a 5bars converter :
 - For 4mA, display indicates 0.000
 - For 20mA, select 5.000 (for the maximum value)
- Output: 250VAC / 0.5A relay on safety sockets 4mm
- Output: 12VDC (allow the wiring a 4-20mA loop without an external supply)
- Alarms: high and low, relay output on safety sockets 4mm
- Settings: offset, hysteresis, gain, filter
- Dimensions: 145 x 185 x 100 mm

COMMUNICATING MODEL SCHNEIDER®



ref. TOR-COM

- LCD display in 11 segments of 3 colours (green, red, orange)
- 1 0-10V input, 4-20mA thermocouple on safety sockets configurable from the keyboard or the software.
- 1 relay output dedicated to heating or cooling on safety sockets.
- 1 All-or-nothing alarm output on safety sockets
- Auto setting or automatic reset
- Hysteresis functions for the activation or deactivation control
- 230 VAC power supply by power cord
- ZELIO temperature software + connection cable to PC supplied
- Dims: 150 x 200 x 100 mm

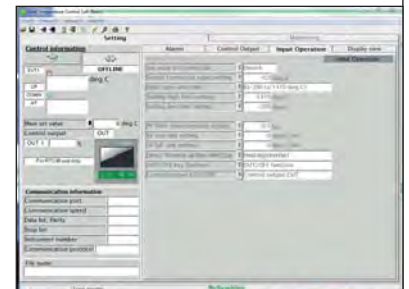

PID regulators for regulation

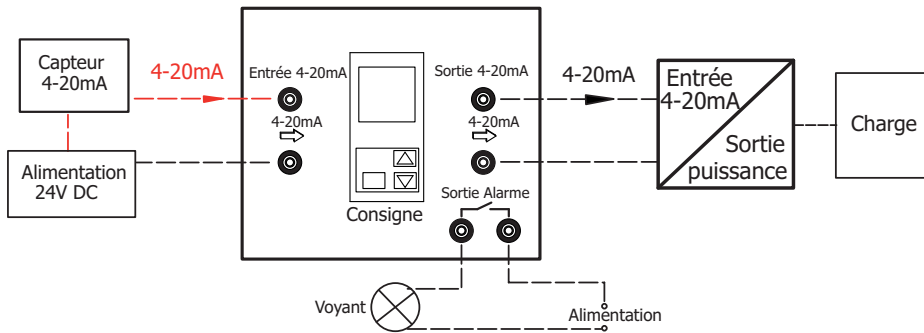

The PID regulator is the correcting component into a regulation loop for the monitoring of a process (boiler, compressor, pump ...). It receives a 4-20mA signal from the sensor which is the image of the value to regulate (temperature, pressure, flow...). It compares it to the set-point (programmed in the PID) and drive the process to reduce the difference "process variable / set-point"

The communicating version has the same features and includes in addition a possible programming by software and retrieving datas (files + curves).

STANDARD MODEL



ref. AT403-BOX

- Automatic tuning and manual PID
- 4 digits display for the instant value
- 4 digits display for the set-point
- Bar graph image of the power output
- 4-20mA input on safety sockets 4mm
- 4-20mA output on safety sockets 4mm
- 250V / 5A relay output on safety sockets 4mm
- Alarms output (high & low) on safety sockets
- Internal timer
- Supply: 240VAC - 50Hz
- Dimensions: 145 x 185 x 100mm

DC POWER SUPPLY

ref. AD1-24

24V / 2.2A DC Supply. Output on safety sockets 4mm. Protection: overload and short-circuit by electronic limitation



COMMUNICATING MODEL GEFRAN®



ref. PID-G

- Universal input on safety sockets
- Configurable according the different types of signals like thermocouple, thermoresistance, thermistance 0-10V and 4-20mA linear outputs.
- Configurable output in 0-10V and 4-20mA on safety sockets.
- All-or-nothing alarm relay output on safety sockets.
- The PID unit is fully configurable from the keys on the front panel or from the software.
- Power supply (230VAC – 50Hz) – power cord
- Programming software + connection lead to PC delivered with the unit
- Dims: 150 x 200 x 100 mm



System for heat regulation by P.I.D.

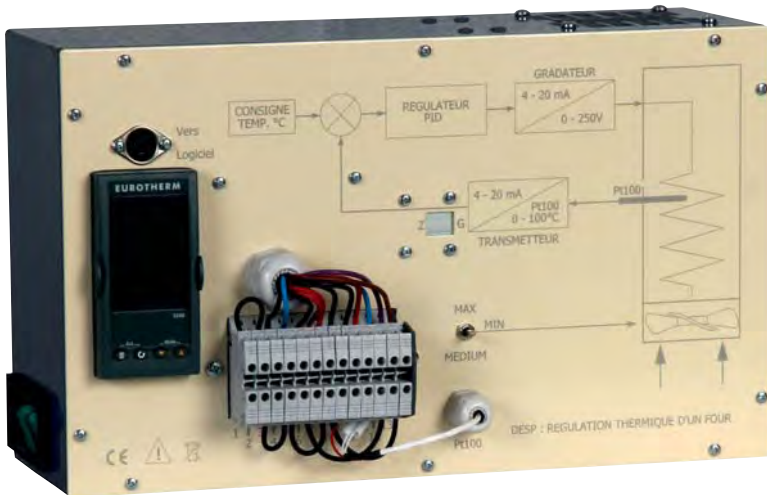

ref. DESP

EDUCATIONAL OBJECTIVES

- Understanding of the regulation principles by PID, from theory to practice.
- Wiring, calibration, loop measuring, statement of curves.

USER'S MANUAL + 15 PRACTICAL WORKS

Practical works

- Wiring of a measuring loop according the standard 4-20mA with Pt100 probe and transmitter
- Calibration of the converter Pt100 / 4-20mA with the help of a decade box (not supply)
- Establishing a calibration sheet, drawing the calibration curve
- Identifying and testing of a Pt100 probe. Calculation of the current through the Pt100 probe.
- Measuring of a loop current without opening the loop
- Using a 4-20mA calibrator
- Establishing the functional diagram and determining the role of different components
- Establishing the loop diagram of regulation and the wireline diagram
- Identifying the controlled value, the monitoring value, the disturbance values.
- Determining the direction of action of the regulator, according to the direction of the process and the direction of the correction member
- Determining the static characteristics of the process (static gain, timeout, time constant) in order to calculate the transfer function
- Determining the oscillations period and the gain of the critical loop, the integration factor. Determining using models Broida and Pessen correctors P, I and D
- Viewing of the response curves with 3 correctors: P, I and D
- Adjusting of the PID correctors and testing according two methods: enslavement and regulation
- Testing of different empirical methods for adjusting PID correctors
- Troubleshooting training by fault simulation

FEATURES

- Supply : 230VAC
- Dimensions : 350 x 200 x 122 mm
- Weight : 3.7kg

This small oven, where an air stream is used to bring the parts to the correct temperature, is equipped with PID to control the temperature accurately to within a tenth of a degree. The DESP model uses only industrial components. The PID control system - 4-20mA standard for measuring input and output - controls air stream temperature. To prevent any risk of burning, oven power has been limited to 250W and air temperature to 100°C. The student wires the Pt100 3-wire probe, 4-20mA measuring loop, 4-20mA control loop, temperature transmitter, and loop power supply to the terminal strip. Current is measured at the conversion resistance using a multimeter, without opening the loops. Maximum accessible voltage (without dismantling the apparatus): 24VDC. The system operates in two modes: automatic and control. In the latter case, an adjustable-speed fan sets up a disturbance. The terminal strip and components are suitable for demonstrating all types of wiring errors and troubleshooting. The temperature and thermostat control current graphs (used to determine static, loop, and critical gains, as well as dead time, and the time constant) are produced either manually (possible due to the slow changes in temperature), or on a PC using LOGIFOUR software (option) and PC interface.

In aeronautics, gluing techniques between metals and composite materials require accurate temperature of polymerization glues, to ensure maximum grip.

This model of oven of glues polymerizing, which the airflow is used to carry the parts to be glued to the appropriate temperature, has a PID temperature regulation accurate to a tenth of a degree.

OPTION INTERFACE & LOGIFOUR SOFTWARE

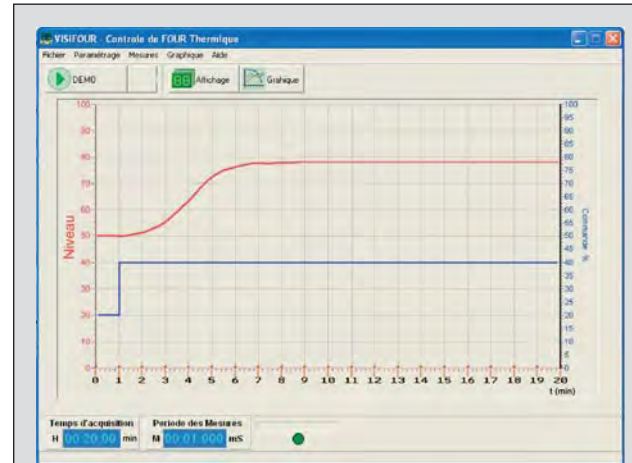

ref. LOGIFOUR

This PC interface – connected to the DB9 outlet – and software are used to record and draw graphs of temperature and heating control directly on PC. The connection to PC is made by USB.

ADDITIONAL FUNCTIONS

- Digital display of the two variables
- Cursor function
- Data transfer to plotter
- Zoom function

OPTION 4-20mA LOOP CALIBRATOR



- Programming in % of the output span to supply a typical intensity like 4 – 8 – 12 – 16 or 20mA
- linear ramps, manual ramps, auto ramps
- Display: 5 digits
- Carry case, user's manual, external battery Pack (for 6x 1.5V AA batteries)
- Input for mains adapter DC 12V (not included)
- Dimensions : 88x168x26mm Weight : 330g

ref. VA100

RANGE	RESOLUTION	ACCURACY
4 - 20 mA	1 µA	0.025% + 5µA
0 - 20mA	1 µA	0.025% + 5µA
0 - 24mA	1 µA	0.025% + 10µA
4 - 20V	1 mV	0.05% + 5mV
0 - 20V	1 mV	0.05% + 5mV
0 - 24V	1 mV	0.05% + 10mV

Air conditioning system



ref. CLIMABOX

EDUCATIONAL OBJECTIVES

- Understanding of the functioning of an air conditioning system
- Performing maintenance operations

USER'S MANUAL + 6 PRACTICAL WORKS

Proposed Practical Works

- Temperature stabilization by simple fan, air conditioner alone, by ventilation and air conditioner.
- Sudden internal heat
- External temperature too low (winter)
- Condensation problems
- Incorrect design of the air conditioner preventing temperature stabilization
- Adjustment of the temperature set point

CLIMABOX is an air conditioned industrial electric board, often used in industry where electronic components need a steady temperature.

Delivered with wiring diagrams and practical works.

MAIN COMPONENTS

- A complete air conditioning system
- An extractor fan
- Many heating resistors
- Two counters : start and time
- Four digital thermometers
- One alarm buzzer

FEATURES OF THE BOARD

- 230V/50Hz single-phase power supply
- Dim : (L x W x H) 550 x 450 x 650 mm - Weight: 45kg

Power factor correction system

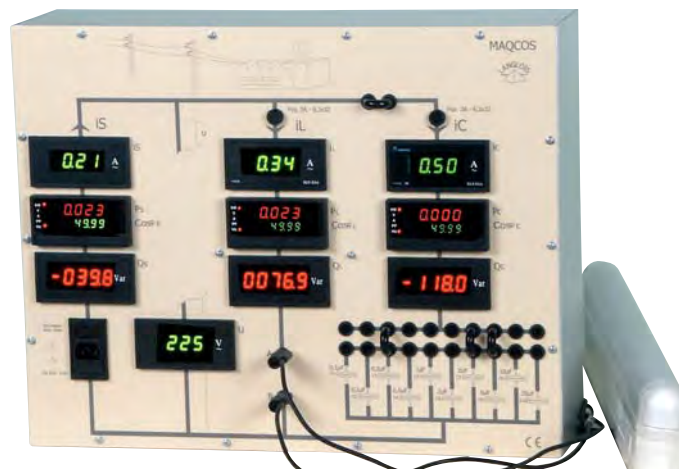

ref. MAQCOS

EDUCATIONAL OBJECTIVES

- Studying the power factor & Demonstrating the interest of power factor corrector for the cost of the power (kWh)

USER'S MANUAL + 3 PRACTICAL WORKS

Proposed Practical Works

- studying of an industrial lighting installation from fluorescent tubes:
Current of branches – power of the transport line with and without power factor correction – Active and reactive power in the branches – Fresnel diagrams
- Study of the pure inductance of a plant in working in order to determine the capacitor bank necessary
Role of automatic compensation
- Study of resonance, max / min current

The MAQCOS model is designed for studying and rectifying power factors.

It consists of three branches:

- source branch, S, representing the energy supplied by the electricity mains (Network)
- plant branch, L, symbolizing a plant's energy consumption
- plant branch, C, including the padding condensers (integrated in the model and connected using jumper wires)

Each branch is equipped with the same measuring instruments:

- ammeter
- wattmeter, measuring active energy
- Power factor meter, measuring the power factor
- varmeter, measuring reactive energy

Students are thus able to compare four electrical variables in the three branches at the same time. They will observe (surprisingly?) that the source current value in the mains network branch may be much lower than the value in the plant branches. That source reactive energy is close to zero when power factor is around 1, whereas plant reactive energy is at maximum value. The model shows the impact of a power factor regulator on the cost per kWh transmitted and the resulting electricity bill.

MAQCOS is supplied with a fluorescent tube and IPXX connection.

TECHNICAL SPECIFICATIONS

- 13 displays: 3 x A, 3 x W, 3 x power factor, 3 x VAR, 1 x V
- 10 condensers: 0.1 μ F - 41 μ F
- Fuse protection
- Dimensions: 510 x 400 x 150 mm - Weight 8.2kg

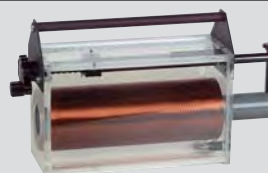

ref. PSYJR

VARIABLE INDUCTANCE OPTION

Students have to find out the pure resistances and inductances of an installation, without interrupting its operation and with a view to deciding on the compensation condenser battery to activate, via a power factor regulator.

Study of the 3rd and 5th order harmonics



ref. HARMOVAR

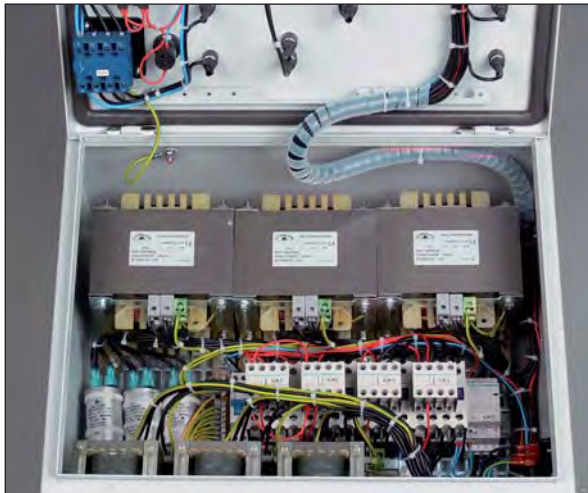

EDUCATIONAL OBJECTIVES

- Studying, putting into service, getting started and setting of the system
- Studying of harmonic filtering of orders 3 & 5 and the power factor
- Practical corrections of harmonics generated by a speed variator.

USER'S MANUAL + PRACTICAL WORKS

Unit on wheels consisting of passive filters used for studying the filtering of the third and fifth order harmonics (and, as a result, the increase in the power factor) during the use of a speed controller for an AC motor or apparatus with a diode-thyristor bridge with a capacitor filter. HARMOVAR uses the industrial methods employed for decreasing the harmonic pollution generated by U/f-type frequency converters or other pollutant receivers with third or fifth order harmonic currents (inverter, switch mode power supply and discharge lamps). The passive filters found there have been specially sized for optimal use and so that the LC-type filtering systems can be studied. They eliminate third or fifth order harmonic currents and show the effect of the third order harmonic current on the neutral.

- The network analyser ref. 6830 (option on page 239) records the harmonic graph
- A switch on the front of the unit is used for activating or deactivating the H3 and H5 filters.
- Jumpers and double channel terminals are used for electrical measurements (current, voltage and power), not only on the network side but also on the receiver side and in each filter.

FEATURES

- Operation on 230V single-phase network or 230V/400V three-phase network
- Fitted with induction coils and capacitors which have been specially calculated for optimum filtering.
- Equipment sized under rated conditions for 1500W motor test bench controlled by frequency converter.
- Compatible with our frequency converters (pages 95-98)
- Supports the max. effective line current: 15A/H3 max: 10A/H5 max: 5A
- Wiring consisting of 4mm safety leads
- Supplied with instructions for use and tutorials
- Easy to move, thanks to its wheels
- Dimensions: 450 x 450mm Height: 530mm - Weight: 73kg



Speed controllers

See Pages 95 - 98

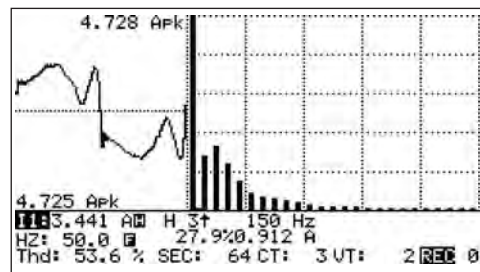
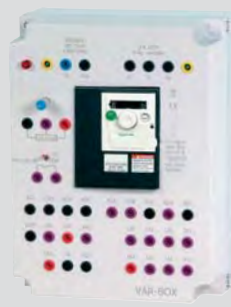

H3 filter activated

Examples of line current measurements taken with our 6830 network analyser (Page 239), on HARMOVAR associated with our ACVAR5 frequency converter (Page 95)

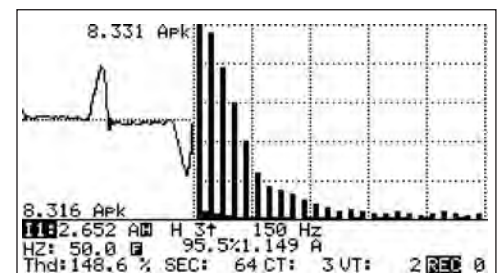

H3 filter deactivated

Power quality control



ref. HARMO-35

EDUCATIONAL OBJECTIVES

- Understanding and using of the method of Fourier series decomposition
- Studying of the power in presence of harmonics
- Understanding the compensation of the power factor by harmonics correction
- Studying the functioning of the dephasing dimmer

USER'S MANUAL + PRACTICAL WORKS

Proposed Practical Works

- Making a power balance in presence of harmonic of currents and voltage
- Observing the disturbances caused by a dimmer
- Raising the power factor, by offsetting a portion of the reactive power and filtering of harmonic of order 3
- Observing network disruptions, caused by a dimmer
- Increasing the power factor by canceling the reactive power (with an anti-resonance circuit)
- Reading the evolution of the PLC program
- Producing a summary document as a record

Four 500W halogen lamps on a tripod are powered by a SCR power regulator which creates harmonic pollution and reactive power degrading the power factor.

A passive filter with an LC circuit is used for:

- minimising the third order harmonic pollution
- measuring the power factor by decreasing the reactive power
- observing the resonance phenomenon.

It is also possible to study the operation of the phase-shift of the SCR regulator.

Principle : the industrial lighting of the panel – simulated by the four halogen lamps on a tripod – varies depending on the ambient sunlight, simulated by one low-voltage spotlight placed in the cabinet. When the current in the halogen lamps is significantly degraded, the filtering components are activated, either manually via the switches on the front or automatically by a PLC.

Auto mode: 3 sunlight levels are programmed. For weak sunlight the 3rd order current harmonic is high. The PLC activates a passive filter which tends to decrease this harmonic.

Manual Mode: a potentiometer is used for continually adjusting the sunlight level. Varying it makes it possible to:

- VIEW, with the help of the network analyser (ref. 6830), the effect of the dimmer on the level of the current harmonics;
- MEASURE THE power factor by inserting a capacitor induction coil. The network analyser reveals that the solution can be found in the induction coil.
- FILTER HARMONIC 3 by using a resonant filter which will reduce noticeably its current

THE FRONT PANEL COMPRISES

- Safety terminals for the measurements
 - voltages and currents supplied by the network
 - voltages and currents in the halogen lamps
 - voltages and currents in the filter components
- Switches for activating or deactivating the filter components
- An Automatic/Manual mode switch
- A lighting potentiometer

OTHER FEATURES

- Light column indicating that the mains power is on
- PLC Software, tutorial and instructions for use are supplied.
- Power supply: 230V 50Hz
- Cabinet: 820 x 400mm Height: 930mm
- Base with wheels, with laminated bench-top: 1200 x 750 x 970mm
- Overall dimensions: 1200 x 750mm Height: 1900mm - Weight: 128kg



Inside view of the cabinet

MEASUREMENT READINGS IN MANUAL MODE WITH A NETWORK ANALYSER (PAGE 239)

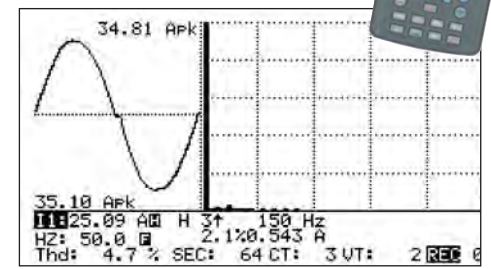

Lighting provided 100% (no harmonics)

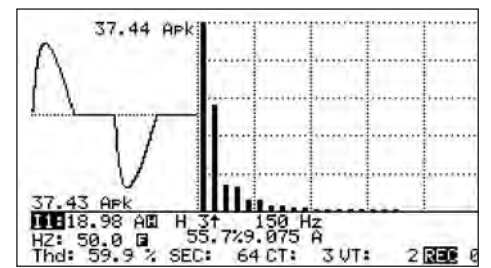

Lighting provided 50% (high third order harmonic)

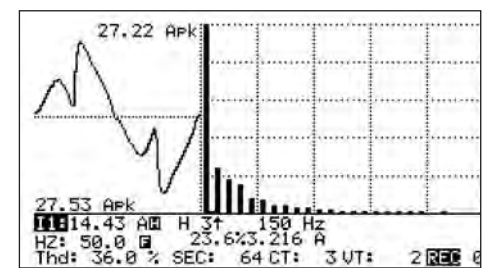

Lighting provided 50% with passive filter (reduction of third order harmonic)

Fault finding in motor

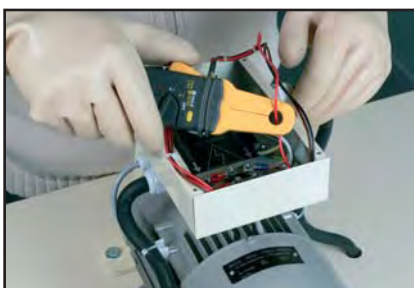

Faults can be looked for inside the student unit and in the motor terminal.

EDUCATIONAL OBJECTIVES

- Simulating common failures encountered with a cage induction motor with brake: damage winding, cut, shorted to ground
- Diagnosis by performing measurements and safety tests

TEACHING RESSOURCES + PRACTICAL WORKS

Practical works

- Cut Winding
- Winding in short circuit
- Winding to ground
- Damaged winding
- Cut brake control system

The user's manual has been made by teachers, allowing the quick implementation of the product and the creation of practical work in the spirit of fault finding in the industry.

ref. MOTODIAG

This complete kit on casters, comprising two back-to-back units and an asynchronous squirrel cage motor and a parking brake, can be used to simulate the faults which occur most frequently. The principle and the instructions have been devised by teachers who want to propose a method for diagnosing faults.

PRINCIPLE

Faults are recreated when the teacher rotates a single switch. Students can take measurements or perform tests in complete safety, regardless of the fault type. Faults can be looked for inside the student unit and in the motor terminal. The unit is isolated from the mains by means of an insulation transformer. In addition, a TT earthing system is recreated on the secondary for safety reasons.

Therefore, even isolation faults are detected by a 30mA differential mechanism. All safety measures are implemented in order to protect individuals and equipment. (See the faults in the description of the teacher unit)

TEACHER SIDE UNIT

The teacher uses this lockable area to manage faults activated by key switches he/she knows, and to view all of the simulator's workings. Thanks to indicator light. The position of the switches and indicator lights remain invisible to students.

The following faults are possible:

- 3 faults involving «damaged coil». A resistor is connected in series with a coil to change its impedance. One switch per phase, or three switches.
- 3 faults involving «power being cut in a coil». The power is cut in a coil. One switch per phase, or three switches.
- 3 faults involving a «short-circuit in a coil». The coils are short-circuited two at a time. One switch per possibility or three switches.
- 3 faults involving «coil earthing». A coil is earthed. One switch per phase, or three switches.
- 1 fault on the brake. The power in the parking brake is cut.

STUDENT SIDE UNIT

This lockable area is used for starting up the simulator (if authorised by the teacher). The transparent door gives the unit a highly didactic appearance.

The student control panel is simpler than the teacher control panel, offering standard normal operation indications. This means that fault finding, testing and measurement are identical to reality in the field.

- Overall dims: 670 x 750 x 1180 mm. Weight: 136 kg
- Laminated bench-top: 670 x 750 mm
- 4 casters Ø 80 mm
- 3-phase Hypra socket on 5m mains cable



Motor start-up studies



DEMARAC is supplied already wired tutorials, a diagram and technical instructions. Safety leads Ø4mm supplied.

The unit can be supplied without the power unit. Please ask us for details.

Compatibility with motors with a power of up to 1500W, with powder brakes controlled 0-12VDC and all 1000RPM tachometer generators with 0-10V, 0-20V or 0-60V outputs.

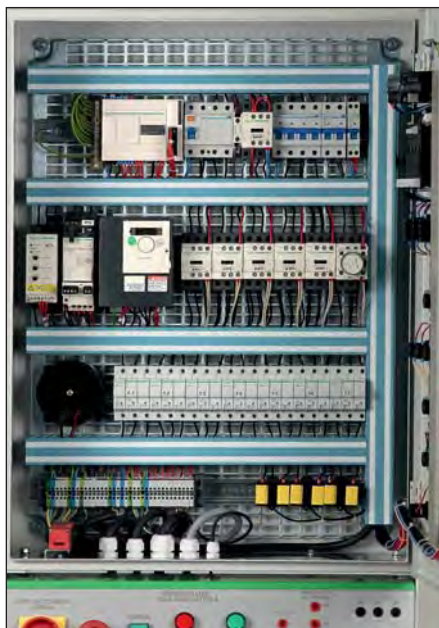

FEATURES

- Three-phase 400V supply voltage.
- Protected by residual current device, circuit breakers and fuses.
- Set of lamps and push-buttons for viewing and controlling the required type of start-up.
- Multifunction measuring unit with digital display, which is wired at the start of the circuit measuring the phase-to-ground and composite voltages, the line currents, the active, reactive and apparent power, in total, the power factor, the THD (total harmonic distortion)
- Digital display showing the motor's rotation speed
- Starter/Decelerator Schneider®. All of the settings are adjusted using potentiometers on the front of the device (acceleration time, deceleration time and torque, etc.)
Acceleration time: from 1.1 to 5 seconds
Deceleration time: from 0 to 5 seconds
Torque adjustment: from 20% to 65% of the breakaway torque of the direct motor
- Frequency converter Schneider® (ATV31 type). Possible adjustments:
 - Acceleration ramp
 - Quick stop/free wheel
 - Pre-selected speeds...
- 2 potentiometers at the front of the cabinet adjust the motor's rotation speed and the motor's load.
- Contactor/circuit breaker, wired upstream of the motor, protect against overloads and short-circuits. A display built into the unit indicates the current consumed by the motor and the thermal protection threshold.
- 300W 400V/690V – 1/0.75A asynchronous motor 1500rpm.
- 300W powder brake. 0-10V power supply
- 20V for 1000rpm tachometer generator

EDUCATIONAL OBJECTIVES

- Understanding the different ways of starting an induction motor

TEACHING RESSOURCES + PRACTICAL WORKS

Proposed Practical Works

- Studying of the functioning star/delta starting, direct, by frequency converter, by soft starter
- Statement of engine characteristics, taking measurement of U and I
- Study of current transformers
- Modification of the acceleration and deceleration ramp of the frequency converter
- Setting the PC connection – PLC

ref. DEMARAC

System for studying the start-up of asynchronous motors. For this completely stand-alone system, all you have to do is connect it to a 3-phase 400V mains socket. Selection of the required motor start-up type via push-buttons at the front of the electrical cabinet.

A 300W asynchronous motor, a powder brake and a tachometer generator are fixed directly onto the base with wheels. The power unit and the electrical cabinet are linked together using 4mm safety leads so that measurements can be taken using a hook-on ammeter or voltmeter, etc.

A key-operated switch at the front makes it possible to use the electrical cabinet when it is switched on with the door open. In this way, a qualified individual may take electrical measurements inside the cabinet.

A multifunction measuring unit displays the electrical quantities on the front door.

A digital tachometer shows the motor rotation speed.

A potentiometer at the front is used for varying the motor load.

- Dimensions:

Base with wheels: 750 x 670mm

Total height: 1970mm - Weight: 118kg

Automatically controlled synchronous machine

TUTORIALS : ALL LEVELS OF TRAINING

Because the motor is open, students can see the air gap, the orientation of the magnetic field, the direction of the current, the direction of rotation, the "active" winding part and the yoke.

MICROMAG can be used as a motor or a generator. By manually rotating the rotor, the machine will operate as a generator. Students read out from the oscilloscope the EMF on the two-phase terminals. This voltage indicates indirectly the torque ripple when the machine is operating as a motor.

EXAMPLE 1

For each of the three phases, students produce a static torque diagram (or EMF diagrams for each phase) based on the rotor's angular position. Students check the values experimentally by measuring torques using a dynamometer and the EMFs shown on the oscilloscope.

They plot torques in a graph and check them experimentally (EMFs respectively) when the two phases are connected in anti-series, or three phases in anti-series and parallel. They produce a phase power diagram based on the rotor's angular position.

EXAMPLE 2

The MICROMAG winding can include one, two or three notches per pole and per phase.

Students perform a theoretical calculation to determine the number of notches and turns of the winding required for a torque specified by the teacher. They then perform this winding on a comb using enamelled wire. Next, they check the obtained static torque in practice using a dynamometer.

EXAMPLE 3

Using these diagrams, students study the principle of the switch, which powers in sequence the phases of a synchronous machine, based on the rotor's angular position. This switch comprises a "position sensor" and "electrical switching".

This is performed in MICROMAG by means of a rotating disk, which is synchronous with the rotor and carries magnets. The magnets activate reed switches, in series with the windings. Students have to place the magnets onto an angular sector of 120° on the switch's disk in order to power two phases. It is also possible to perform a 180° control by using one anti-series phase and the other two in parallel. By manually activating the disk, students check on the ohmmeter whether the opening/closing sequence of the switches matches the previously established phase power diagram exactly, based on the rotor position.

EXAMPLE 4

Students place the windings that they have produced inside the motor. By manually powering one phase after another, they firstly check the connection. Next, they connect the switches of the switching system with the three phases of the stator. By overriding the rotor/switch drive system, students check that its rotation is driving the rotor in synchronism. Finally, by resetting the switch drive by the rotor, students test the machine in automatically controlled operating mode. Students read out from the oscilloscope the currents in two successive phases and their conduction diagram.

EXAMPLE 5

The aim of the tutorials is to draw students' attention to the various power supply strategies, with a view to establishing a rotating field. To this end, they have a document to complete, which shows the successive angular positions of the switch and the rotor, the status of the switches, the current in the windings and the angular diagrams for each phase. They must determine the shape of the torque for each phase, as well as the resulting torque.

TUTORIALS : UNIVERSITY & ENGINEERING SCHOOL

- Principle of axial motor
- Main μ_a and J_a parameters of a permanent magnet
- Recoil line
- Ampere-turns of a coil equivalent to a magnet.
- Hypotheses about the field and materials
- Magneto-static laws used
- Calculation of field B and comparison with the measurement
- Motor torque calculation Generator EMF calculation
- Relationship between EMF and torque
- Calculation of a number of turns for a given torque
- EMF waveform for a winding with one notch
- Torque wave form for a winding with one notch
- Calculation of the resistance of a phase. Practical check
- For each phase power supply strategy
 - establish the opening and closing sequences of the switches
 - wire the control circuit.
 - based on the waveforms of the torques for each phase, determine the waveform of the resulting torque and currents
 - determine the optimal polar arc

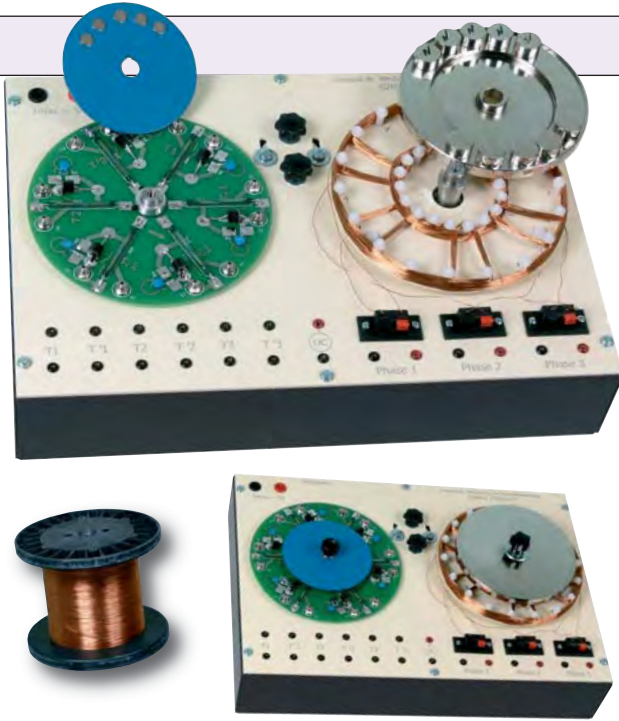

ref. MICROMAG

SCOPE OF SUPPLY

Supplied complete and in working order, together with:

- 1 wound stator
- 2 additional bare combs for winding
- enamelled wire dia. 0.5 mm
- 14 leads dia. 2 mm
- 1 full set of instructions with amended tutorials.

EDUCATIONAL OBJECTIVES

- Identifying the internal components of a auto-controlled synchronous machine (theoretical and practical)
- Functioning in motor and in generator
- Achieving the coils and set the switch

TEACHING RESOURCES MADE BY THE SCHOOL ENSEIHT

MICROMAG uses only dry contacts (with no complex electronic circuit) so that its operation is accessible to everyone. Using this model, students discover little by little the various components of an automatically controlled synchronous machine and, more generally, of a motor, via a theoretical and practical approach. The theoretical approach can be accessed at different study levels. At the secondary school level, the torque, the EMF and the number of turns in the winding are calculated simply by applying formulae. Engineering students will have the necessary mathematical knowledge to establish these relationships by using the laws of electromagnetism and applying them to the MICROMAG machine.

MICROMAG comes with a manual containing all of the basic laws which are necessary for understanding the tutorials. Wherever necessary, colour drawings are used to illustrate comments. Angular diagrams, timing diagrams and schematic diagrams are used to illustrate, step-by-step, the operation and/or stages of implementation.

In addition, the following is required for all tutorials:

- a 30V DC 2A power supply
- an oscilloscope with a memory function
- a dynamometer
- a gaussmeter – not essential – used for checking the current of the field
- enamelled wire for winding on the rotor(s) (supplied)

Electronic & electrical circuit lab



Electronic circuit lab equipped with a main unit and 11 experiment modules. Each module permits to realize several practical work. Supplied with leads and user's manual.



ref. PSY2101

EDUCATIONAL OBJECTIVES

- Studying by different modules of electrical & electronic circuits commonly encountered

TEACHING RESSOURCES + PRACTICAL WORKS

11 EXPERIMENT MODULES

Designed with a 215 x 165 x 30mm solid body plastic housing, with electrical wiring printed on the front panel. An 8-bit DIP switch, located on the right top corner allows the user to simulate faults. Each analogue module is delivered with 2 experiment manuals.

STUDENT BOOK

(supplied with each module)

A theoretic part, definitions, terminology, characteristics curves, schemas, theoretical schemas, and wiring diagrams with link slots. The functioning is explained in details.

An experimental part to guide step by step the student to do practical works: choice of measurement appliances, settings, measurement to do, blank tables to be filled, curves to be drawn.

Result commentaries, additional practical works

INSTRUCTOR BOOK

(supplied with each module)

Practical works presentation: purposes, manipulation interpretation

Switches position to simulate troubleshooting.

Detailed and pedagogical solutions of practical works

Calculation shown in extenso. Moreover, the instructor will find technical complements, which can be distributed to students without any modifications.

MAIN UNIT PSY2101 INCLUDING

4 fixed DC supplies with output overload protection
+5V -5V +12V -12V / 300mA on each output.

Dual DC power supply with output overload protection
 $\pm 3V$ to $\pm 18V$ / 1A continuously adjustable.

AC power supply with output overload protection
0-9VAC / 500mA

Signal generator

Sine, square and triangle 10Hz to 100kHz.

- 4 ranges 100Hz - 1 - 10 - 100 kHz

- Output impedance: 50 Ω

- Output voltage : 9Vpp (with 50 Ω load),
18Vpp (open loop).

3 1/2 digit digital voltmeter and ammeter

Range: 2V - 200V - accuracy 0.3%

Range 200 μ A - 2A - accuracy 0.5%

Analogue voltmeter and ammeter

0 to 20V DC - 0 to 100mA DC - 0 to 1A DC

0 to 15 V AC - 0 to 100mA AC - 0 to 1A AC

Speaker 8 Ω , 0.25W with driver circuit.

0.25W potentiometers : 1k Ω , 10k Ω , 100k Ω , 1M Ω .

Breadboard : 1680 tie-point breadboard on top panel can be easily put into and taken off (permutable).

Dim: 400 x 300 x 130 mm. Weight: 5.8kg

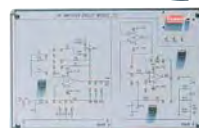
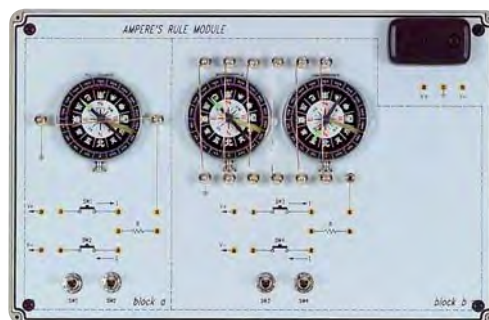

DC voltage and current measurement.

Ohm's law. Power in DC circuit.

Series - Parallel network and Kirchoff's law.

Thevenin's and Norton's theorems.

Maximum power transfer theorem.

RC circuit and transient phenomena. AC voltage and current measurement. RC, RL, RLC circuits.

Transformer characteristics.

Series and parallel resonant circuits. LC filter.

ref. ELEC1

Magnetic devices. Magnetic field.

ref. ELEC2

Drawing magnetic curves. Magnetic field strength.

Lenz's and Faraday's laws.

ref. ELEC3

Ampere's rule

ref. ELEC4

Fleming's rule

ref. ELEC5

Self induction. Mutual induction.

Magnetic flux detection by sensor and amplifier

ref. ELEC6

Diode characteristics.

Rectifier circuit half and full wave.

Filter circuit.

LC filters and RC filters in π . Zener diode characteristics.

LED characteristics. Transistor characteristics

NPN PNP Vce IB. Multimeter functions.

FET characteristics.

Triac UJT characteristics.

ref. ELEC7

One stage transistor amplifier.

AB class Push-pull - Voltage regulator - SCR power

dimmer - Two stages amplifier - Relay characteristics

- Touch controller switch.

ref. ELEC8

Two stages amplifiers by transformers.

Coupling - Push-pull output on speaker

Wheatstone bridge.

ref. ELEC9

Photoresistor characteristics - Using a switch.

Thermistor characteristics. Wheatstone using.

Thyristor driven by thermistor.

3 stages amplifiers controlled by microphone.

ref. ELEC10

Blocking oscillator.

Blocking oscillator with speaker output.

Astable multivibrator. LC resonant circuit.

Electronic birdcall circuit

ref. ELEC11

Digital logic lab



Digital logic lab equipped with a main unit and 13 experiment modules. Each module permits to realize several practical works. Supplied with leads and user's manual.

EDUCATIONAL OBJECTIVES

- Studying by different modules of logic circuits commonly encountered

TEACHING RESSOURCES + PRACTICAL WORKS

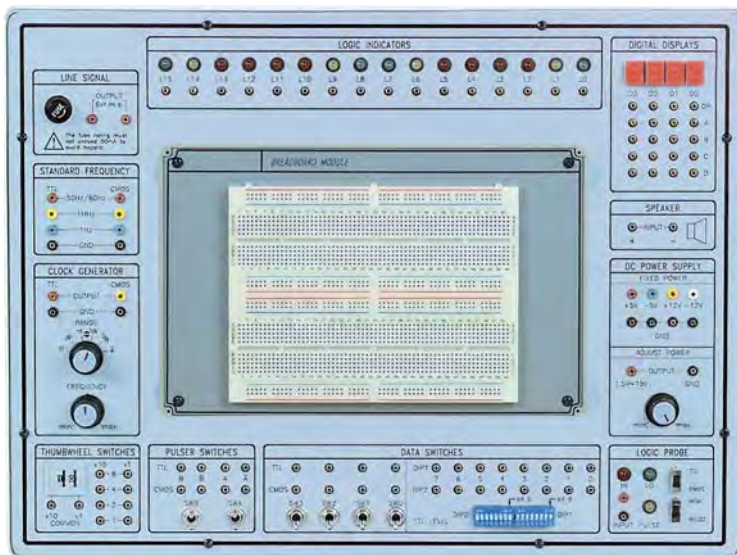

ref. PSY3101

PSY3101 MAIN UNIT WITH:

- 4 fixed DC supplies with output overload protection: +5V -5V +12V -12V / 300mA on each output.
 - 1 adjustable DC power supply with output overload protection: from 1.5 to 15V / 500mA
 - 3 fixed frequencies: 1Hz, 50Hz, 1MHz 0.01%, fanout : 10 TTL load
 - 1 variable signal generator
 - 6 ranges from 1Hz to 1MHz - Fanout: 10 TTL or CMOS load.
 - 2 x 8 outputs, edge 0 \square 1 TTL level
 - 4 outputs: edge 0 \square 1 TTL or CMOS level each with debounce circuit
 - 1 fixed AC output - 6Vrms with overload protection
 - Thumbwheel switch, 2 digit, BCD code output, common point input.
 - 16 x LED indicating high and low logic state
 - 4 sets of independent 7-segment LED display, with BCD.
 - 3 x LED functioning as a logic probe.
 - 1 speaker with driver circuit.
- Dimensions : 400 x 300 x 130 mm. Weight : 5.8kg

ACCESSORIES SUPPLIED

- 1680 tie-point breadboard which can be easily put into and taken off (permutable with the modules).
- jumpers, leads

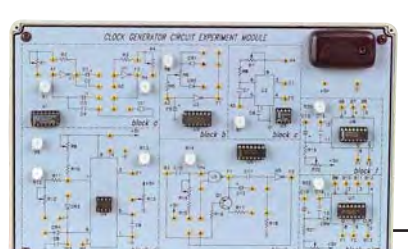
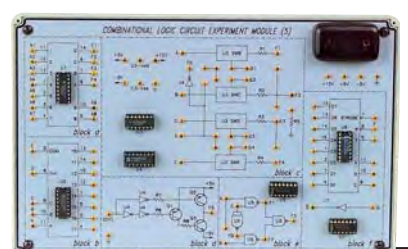
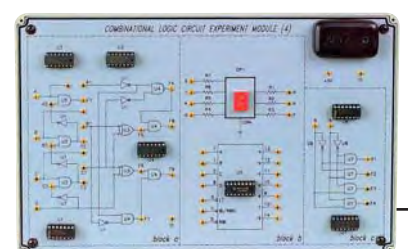
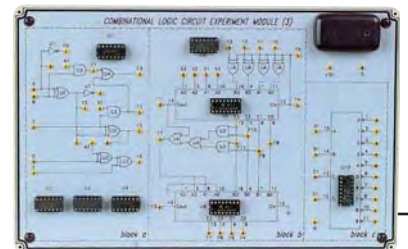
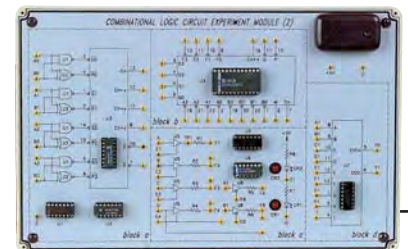
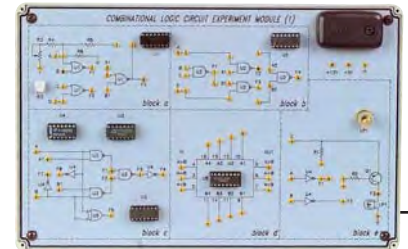
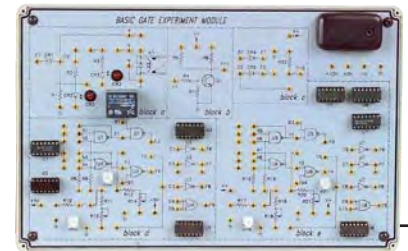

Logic gates circuits, transistors, TTL and CMOS logic circuits. TTL/CMOS I/O voltage and current measurement experiments. Basic logic gate transmission delay measurement. AND, OR, NAND, NOR, XOR gate characteristics. Interface between TTL/CMOS and CMOS/TTL.

ref. DIGITAL1

NOR NAND XOR gate circuits, reverser, comparator circuit experiments, Schmitt trigger, open collector gate circuits.

ref. DIGITAL2

Three-state gate circuit. Adder. Arithmetic logic unit. Bit parity generator.

ref. DIGITAL3

Adder. Subtractor. 2 and 3 inputs reverser. BCD code adder circuit. Bit parity generator with XOR gate. 10 to 4 bit decoder with TTL IC.

ref. DIGITAL4

4 to 2 bit encoder. 4 to 2 bit decoder. Decoder circuit experiments (decoding 7-segment display with BCD code).

ref. DIGITAL5

10 to 4 bit encoder. Multiplexer circuit experiments. Digitally controlled analog Multiplexer/demultiplexer circuits. Bi-directional transmission with CMOS IC.

ref. DIGITAL6

Oscillator circuit with basic logic gates, with Schmitt trigger. Voltage controlled oscillator circuit, with 555 trigger. Monostable multivibrator and synchronous astable multivibrator.

ref. DIGITAL7

13 EXPERIMENT MODULES.

Designed with a 215 x 165 x 30mm solid body plastic housing, with electrical wiring printed on the front panel. An 8-bit DIP switch, located on the right top corner allows the user to simulate faults. Solution for faults are listed in the experiment manual for user's reference. Comprehensive experiment and instructor's manual are supplied with modules and contains theoretical drawings, wiring drawings. The experiment part has input signals, location of test points, tables to be filled up, comments and exercises.

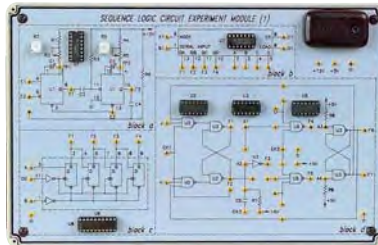

Variable duty ratio oscillator. RS, T, D, JK flip flop. Preset left/right shift register circuit. Noise elimination circuit.

ref. DIGITAL8

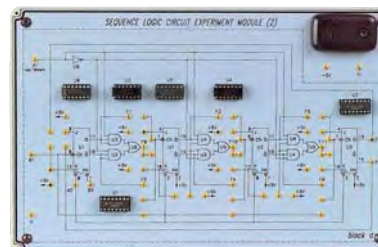

JK flip flop: asynchronous/synchronous, binaries up/down bi-directional counters. Ring counter circuit, Johnson's counter circuit.

ref. DIGITAL9

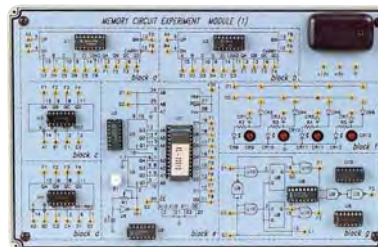

JK flip flop: asynchronous counter: decimal, divide by N, preset synchronous binary/decimal. Constructing ROM memories with diodes, RAM memories with D flip flop. Constructing EPROM

ref. DIGITAL10

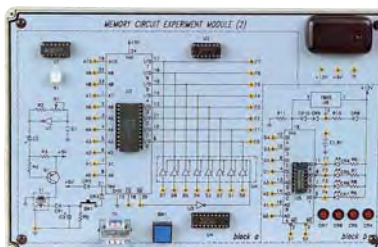

Constructing 64 bits RAM circuit. Constructing Electronic EPROM circuit

ref. DIGITAL11

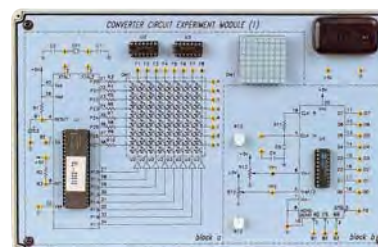

Construction dynamic scanning counter with single chip microprocessor. 8-bit analog/digital converter circuit.

ref. DIGITAL12

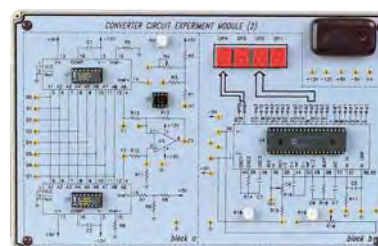

Digital/analog converter circuit, unipolar and bipolar. 3 digits analog/digital converter circuit.

ref. DIGITAL13

Analog circuit lab



Analog circuit lab equipped with a main unit and 17 experiment modules. Each module permits to realize several practical works. Supplied with leads and user's manual.

EDUCATIONAL OBJECTIVES

- Studying by different modules of analog circuits commonly encountered

TEACHING RESSOURCES + PRACTICAL WORKS

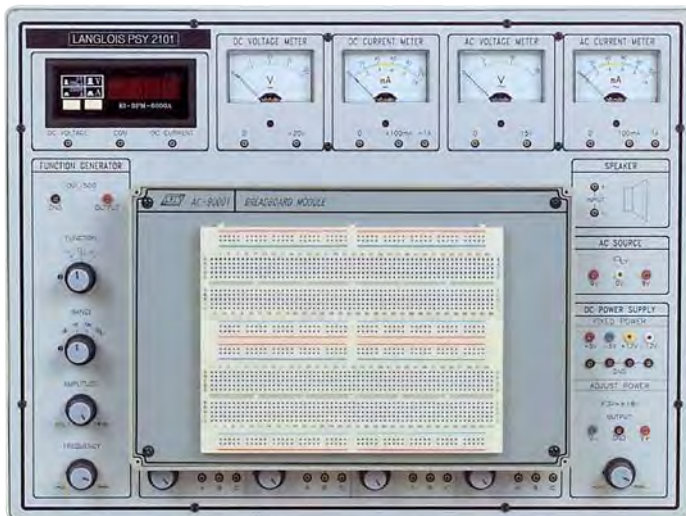

ref. PSY2101

MAIN UNIT PSY2101 WITH :

- 4 fixed DC supplies** with output overload protection
+5V -5V +12V -12V / 300mA on each output.
- Dual DC power supply** with output overload protection
 $\pm 3V, \pm 18V / 1A$ continuously adjustable.
- 2 AC power supplies** with output overload protection 0-9VAC / 500mA
- Signal generator**
Sine, square and triangle 10Hz to 100kHz.
- 4 ranges 100Hz - 1 - 10 - 100 kHz
- Output impedance: 50Ω
- Output voltage : 9Vpp (with 50Ω load), 18Vpp (open loop).
- 3 1/2 digit digital voltmeter/ammeter**
Range: 2V - 200V - accuracy 0.3%
Range 200 μ A - 2A - accuracy 0.5%
- Analogue voltmeter/ammeter**
0 to 20V DC - 0 to 100mA DC - 0 to 1A DC
0 to 15 V AC - 0 to 100mA AC - 0 to 1A AC
- Speaker 8 Ω , 0.25W** with driver circuit.
- 0.25W potentiometers** : 1k Ω , 10k Ω , 100k Ω , 1M Ω .
- Breadboard**: 1680 tie-point breadboard wich can be easily put into and taken off (permutable with the modules).
- Dimensions : 400 x 300 x 130 mm. Weight : 5.8kg

17 EXPERIMENT MODULES.

Designed with a 215 x 165 x 30mm solid body plastic housing, with electrical wiring printed on the front panel. An 8-bit DIP switch, located on the right top corner allows the user to simulate faults. Each analogue module is delivered with 2 experiment manuals.

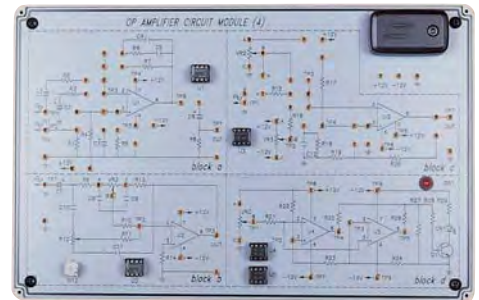

REF. ANALOG 1

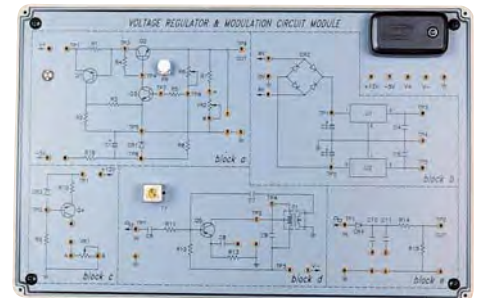

REF. ANALOG 2

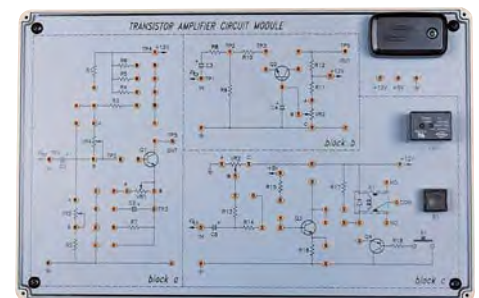

REF. ANALOG 3

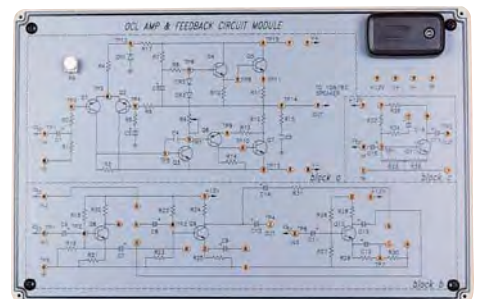

REF. ANALOG 4

Silicium, Germanium, Zener, Photodiode and LED diode characteristics experiments.
Clipping and clamping circuits
ref. ANALOG1

Half wave and full wave rectifier circuit.
Bridge rectifier circuit.
Dual power rectifier circuit.
Voltage doubler & multiplier circuit.
RC direct current charge & discharge circuit.
Differentiator, integrator.
RL charge & discharge circuit.
NPN and PNP circuit. IE IB IC measurement
ref. ANALOG2

Transistor amplification circuit: common emitter circuit, common base, common collector.
Automatic and voltage divider bias point.
Feedback collector/base. Switching.
Switching type transistor circuit. Relay control.
ref. ANALOG3

Darlington's circuit.
Photoelectric control circuit.
Delay control circuit. FET measurement of I_{DSS} , I_{GS} , V_p .
MOSFET measurement of I_{DSS} , V_p - FET and MOSFET amplifiers: common source, common drain.
Schemes.
Automatic and voltage divider bias point.
ref. ANALOG4

Two stage amplifier circuit, RC coupled.
Direct coupled amplification circuit.
Transformer coupled amplification circuit.
Push-pull amplification circuit with impedance adapter transformer.
ref. ANALOG5

Condenser coupling multi-stage amplification circuit.
OTL amplification circuit.
OCL amplification circuit.
IC amplification circuit.
ref. ANALOG6

Multistage amplifiers with direct coupling.
Transistor negative feedback circuit.
Serial voltage negative feedback circuit.
Parallel voltage negative feedback circuit.
Serial current negative feedback circuit.
Parallel current negative feedback circuit.
ref. ANALOG7

Direct feedback circuits. Low frequency sine wave oscillating circuit (RC phase-shifting and Wien bridge oscillator circuit). High frequency sine wave oscillating circuit (Hartley oscillator circuit). Astable oscillating circuit with fixed or adjustable frequency and output on transformer.
ref. ANALOG8

Sine wave oscillating circuit (Colpitts).
Crystal.
Square generator with fixed variable frequency, flip-flop, timers, divider by Z.
Bistable, Intermittent oscillating circuit.
ref. ANALOG9

Schmitt's trigger circuit. Sawtooth wave oscillating circuit linear ramp generator. Regulated voltage/current circuit with zener diode/transistor.
Regulated adjustable voltage. Current limiting.
ref. ANALOG10

Regulated voltage circuit with IC. Constant current circuit. Amplitude modulation circuit (AM).
ref. ANALOG11

Frequency modulation circuit (FM).
Transistor differential amplification.
Characteristics of OP amplifiers: input/output impedance, bandwidth, slew rate, offset voltage measurements for direct and inverse amplifier.
ref. ANALOG12

OP amplifier circuits: inverse and non inverse amplification, voltage follower, Difference amplification, Sum amplification, clipping circuit, constant voltage and current circuit, integrator circuit.
ref. ANALOG13

OP amplifier circuits: logarithm amplification, exponential amplification circuit, peak value detection circuit, precision clipping circuit, voltage regulator circuit, sampling/hold circuits.
ref. ANALOG14

OP amplifier : instrument amplification circuit, high pass, low pass and band pass amplification circuit.
ref. ANALOG15

Tone controller circuit. RIAA amplifier circuit.
Single power bias amplification circuit.
Positive feedback OP amplifier: comparator, Schmitt trigger, window type comparator.
ref. ANALOG16

Operational amplifier oscillators:
Monostable and astable multivibrator: square wave generator.
Sine wave: oscillation circuit:
RC oscillator, Wien oscillator.
ref. ANALOG17

STUDENT BOOK (supplied with each module)

- A theoretic part, definitions, terminology, characteristics curves, schemas, theoretical schemas, and wiring diagrams with link slots. The functioning is explained in details.
- An experimental part to guide step by step the student to do practical works: choice of measurement appliances, settings, measurement to do, blank tables to be filled, curves to be drawn.
- Result commentaries, additional practical works.

INSTRUCTOR BOOK (supplied with each module)

- Practical works presentation: purposes, manipulation interpretation.
- Switches position to simulate troubleshooting.
- Detailed and pedagogical solutions of practical works.
- Calculation shown in extenso. Moreover, the instructor will find technical complements, which can be distributed to students without any modifications.

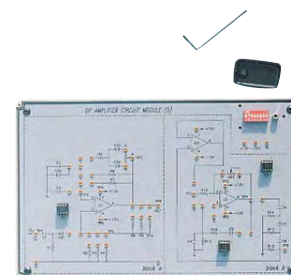

Conversion test benches

RECTIFIER

SINGLE-PHASE / DIRECT CURRENT CONVERSION TEST BENCH

CO-1000 IS SUPPLIED WITH 4 MOVEABLE FRONT PANELS, INSTRUCTION BOOK INCLUDED TUTORIALS

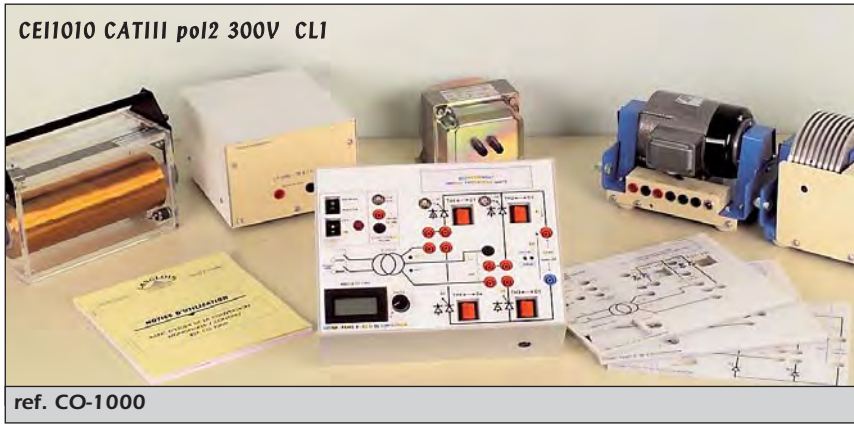

CEI1010 CATIII pol2 300V CL1

ref. CO-1000

ACCESSORIES FOR CO-1000

Ref. ECO1/2 10 Ω	Rheostat ECO1/2 10 Ω (P.110)
Ref. SH90/24	Motor 90W (P.72)
Ref. FR90	Powder brake FR90 (P.73)
Ref. PSYJR	Variable coil (P.117)
Ref. CO-104	Smoothing coil 40mH - 3A
	Advised option
Ref. CO-105	Smoothing coil 20mH - 3A
Ref. CO-108	Smoothing coil 60mH - 3A
Ref. CO-106	12V/24V Battery

EDUCATIONAL OBJECTIVES

- Studying of the controlled, non-controlled and mixed rectification of the single-phase

TEACHING RESSOURCES + PRACTICAL WORKS

All types of practical tests on the rectification of controlled and uncontrolled single-phase current can be carried out with this single box, which comprises built-in supplies (including a power supply), a probe for measuring the AC+DC current output, an ignition angle display, and 4 switches to change from the diode assembly to the rectifier assembly. The test bench is supplied with 4 moveable front panels. Each one is a specific mask, with holes for the indicator lights, input/output terminals, and switches required for a particular set of tests. Each panel is printed with the instructions for just those tests. None of the components are directly accessible to avoid short circuits. Rectifiers and diodes are specially mounted to facilitate maintenance and are visible behind a movable, transparent cover. The 30V x 6A output is capable of running a powerful motor (electrical power: 150W, mechanical power: 90W) connected to a brake, making it possible to observe the influence of braking on the conduction angle.

The instruction book supplied with the test bench explains the tests listed below for each front panel.

RECTIFIER CONTROL

The ignition angle is controlled by a potentiometer and displayed. The control pulses, applied to the trigger through separation pulse transformers, are output via BNC to the oscilloscope.

CURRENT PROBE

This probe consists of a Hall-effect sensor and is connected in series, like an ammeter. The current image is a voltage of 0.5 V/A available via BNC.

INDICATOR LIGHTS

LEDs indicate which rectifiers and diodes have been selected, which transformer windings are connected to the power supply, and the rectifier / inverter mode.

BUILT IN 200VA POWER SUPPLY

2 mid-point reactors: 2 x 15 Vrms
Power supply: 230VAC 50Hz 250VA
Dimensions: 670x370x170mm. Weight: 5.2kg

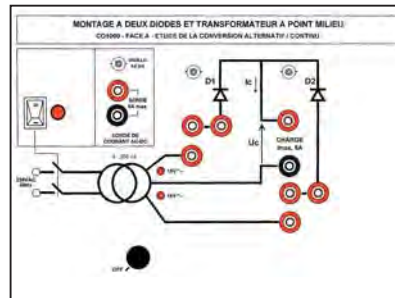

PANEL A: ASSEMBLY WITH TWO DIODES AND MID-POINT TRANSFORMER

Return to single half-wave rectification and switching to double half-wave rectification by simply adding jumper straps.

- Experiment 1 Power flow on resistive load (R)
- Experiment 2 Power flow on inductive load (R,L)

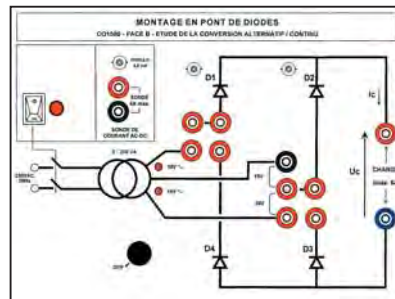

PANEL B: DIODE BRIDGE CIRCUIT ASSEMBLY

- Experiment 1 Power flow on resistive load (R)
 - Experiment 2 Power flow on inductive load (R,L)
 - Experiment 3 Power flow on active load (E,R)
 - Experiment 4 Power flow on active inductive load (E,R,L)
 - Experiment 5 Application to a DC motor power supply
- Any of these 4 diodes can be replaced by a rectifier at any time, simply by throwing the appropriate switch. This facilitates comparisons between all-diode, all-rectifier, symmetrical mixed, and asymmetrical mixed assemblies.

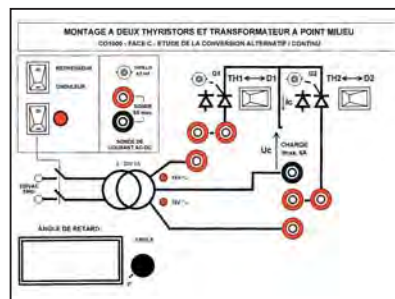

PANEL C: ASSEMBLY WITH TWO RECTIFIERS AND MID-POINT TRANSFORMER

Controlled single- and double-wave rectification. The tests on panel A may be used again for comparison.

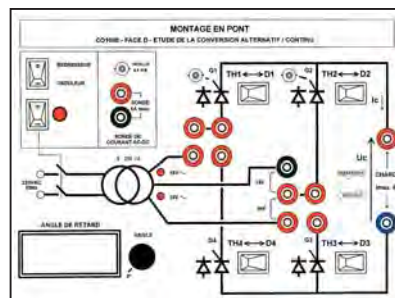

PANEL D: BRIDGE CIRCUIT ASSEMBLY (ALL RECTIFIERS OR MIXED)

- Comparative studies of diode / rectifier / mixed assemblies
- Experiment 1 Power flow on active inductive load (E, R, L)
 - Operates as a static convertor
 - Operates as a grid-interactive inverter
- Experiment 2 Application to a DC motor power supply (DCM)
 - Mixed bridge-circuit assembly
- Experiment 3 Power flow on active inductive load (E, R, L)
- Experiment 4 Application to a DC motor power supply (DCM)

INVERTER

SINGLE-PHASE CONTINUOUS/ALTERNATING CURRENT CONVERSION TEST BENCH
 CO-1000 IS SUPPLIED WITH 2 MOVEABLE FRONT PANELS, INSTRUCTION BOOK INCLUDED TUTORIALS

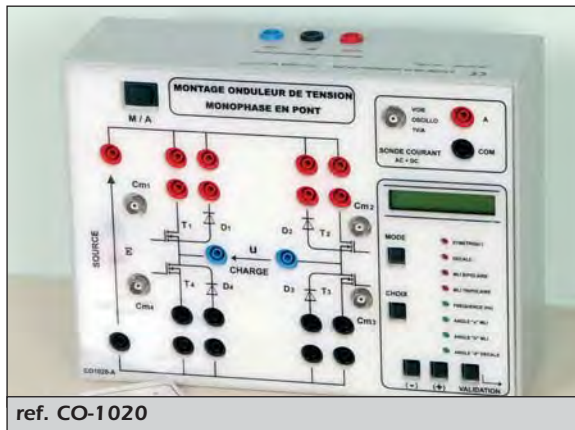

ref. CO-1020

ACCESSORIES FOR CO-1020

Ref. ECO1/2 10Ω	Rheostat ECO1/2 10Ω (P.110)
Ref. ECO1/2 15Ω	Rheostat ECO1/2 15Ω (P.110)
Ref. ECO1/2 22Ω	Rheostat ECO1/2 22Ω (P.110)
Ref. ECO1/2 33Ω	Rheostat ECO1/2 33Ω (P.110)
for an optimal use, low resistance loads are better	
Ref. PSYJR	Variable coil (P.117)
Ref. CO-106	12V/24V Battery
Ref. CO-107	Single-phase transformer 12V - 230V with its lamp 230V - 40W
Ref. CO-109	load made up of a 40W machine 12V/230V
Ref. CO-122	Capacitor 22μF

EDUCATIONAL OBJECTIVES

- Studying of a 24V single-phase inverter, in half bridge and in bridge

TEACHING RESSOURCES + PRACTICAL WORKS

This bench is suitable for all types of tests on independent, single-phase static voltage converters. It has 2 detachable front panels, with holes forming a mask that reveals the layout diagram for the specific type of test to be carried out.

The choice of layout (consisting of MOS power transistors) is thus determined by the front panel slotted into the casing:

PANEL A: "Single-phase, static, half-bridge voltage converter (two switches)"

PANEL B: "Single-phase, static, bridge voltage converter (four switches)"

The system includes a control panel offering the following options: (SYMMETRICAL, OFFSET, BIPOLAR PWM, and THREE-POLE PWM), a display (frequency and offset angles), indicator lights (control mode selection and adjustment parameters), and an AC+DC current probe for measuring and displaying all the current in the layout. It runs both on batteries and the laboratory continuous power supply and has reinforced safety systems (for reversed polarity and shutdown of unused transistors). The output ($I_{MAX} = 3A$) is sufficient to run a motor of significant power and, in particular, to study the U/F control.

TRANSISTOR CONTROL PANEL

This flexible, easy-to-use control panel is entirely managed by micro-controller and is capable of all variable frequency controls.

CONTROL MODE

The control mode is selected by pressing the "MODE" key:

- SYMMETRICAL
- OFFSET
- BIPOLAR PWM
- THREE-POLE PWM

A LED indicates which mode has been selected.

SELECTING ADJUSTMENT PARAMETERS:

Adjustment parameters are selected by pressing the "SELECT" key:

- FREQUENCY (Hz)
- OFFSET ANGLE
- 1st ANGLE "α" IN PWM
- 2nd ANGLE "β" IN PWM

A LED indicates which parameter has been selected. In PWM mode, the signal pattern is determined by the size of the angle (α, β) selected (which amounts to setting the pulse width). Depending on the values of these angles, it is possible to eliminate the 3rd- and 5th-rank harmonics to obtain a spectrum with fewer harmonics, closer to the sinusoid curve.

CURRENT PROBE

This probe measures AC, DC, and AC + DC current and is connected in series, like an ammeter, in the circuit to be measured. A BNC terminal displays an image of the current intensity at a voltage of 1 V/A.

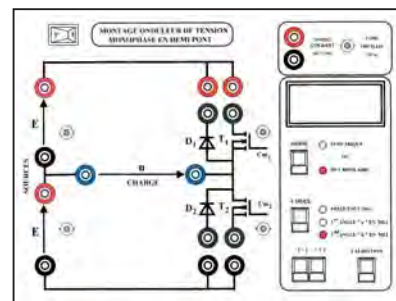

PANEL A "SINGLE-PHASE, STATIC, HALF-BRIDGE VOLTAGE CONVERTER (2 SWITCHES)"

The diode and power transistor operate by cross-barring
 Presentation of symmetrical control

Presentation of the Pulse-Width Modulation control: Bipolar PWM wave

Experiment N°1: Throughput over resistive load (R)

Experiment N°2: Throughput over inductive load (R, L)

Experiment N°3: Throughput over resonant load (R, L, C)

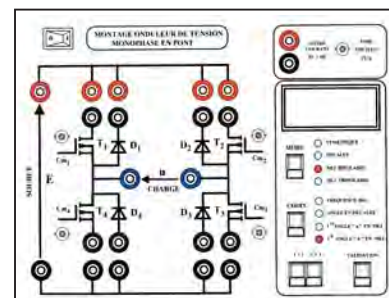

PANEL B "SINGLE-PHASE, STATIC, BRIDGE VOLTAGE CONVERTER (4 SWITCHES)"

Presentation of offset control

Presentation of the Pulse-Width Modulation control: Three-pole PWM wave

Experiment N°1: Throughput over resistive load (R)

Experiment N°2: Throughput over inductive load (R, L)

Experiment N°3: Throughput over resonant load (R, L, C)

Application to induction heating
 Experiment N°4: Application to speed variations in an alternating current motor

Experiment N°5: Application to a backup power supply

Using the "CO-1000 test bench as a charger.

TEST UNITS

Analog test unit



AT106 is a test bed for analog circuits.
Easy maintenance: common circuits and diagrams provided.
Dimensions: 340 x 265 x 130mm Weight 3.7kg. Mains 230V.

1 BOARD 1896 contacts with spacing 2.54, 1,280 bearing the components, 400 for supply distribution.

4 SUPPLIES short circuit protected.

SUPPLY	+5V/1A	0 to +15V/0,3A	0 to -15V/0,3A	-5V/100mA	
REGULATION	<100mV <50mV	<0,05% of V <30mV	<0,05% of V <30mV	Load variation 100% Mains variation 15%	<100mV <50mV

1 FUNCTION GENERATOR Sinusoidal, Square, Triangular, Ranges 0.1Hz à 200 kHz, fine adjustment vernier, Sinusoidal adjustable between 0 and 5Vcc, Triangular 5Vcc, Square 5Vcc, TTL 5V

1 VOLTMETER 0 to 30V analogue, impedance 320 k Ω

1 UNIVERSAL COUNTER 8 DIGITS

Frequencymeter 1Hz to 100MHz. Periodmètre 0,01 μ s to 99 999 999 μ s.

TTL and CMOS Internal / External Input

1 MICRO-AMMETER 0 to 100 μ A analogue, impedance 1k Ω

1 LOUDSPEAKER

4 ADAPTERS

These adapters allow the unit to be connected to an external electronic unit.

- 2 banana inputs of 4mm diameter

- 2 inputs of female BNC connectors

3 SWITCHES

2 to 2 positions and 1 to 3 positions

6 positions rotary switch

2 POTENTIOMETERS 0 to 1k Ω - 0 to 100k Ω

ref. AT106

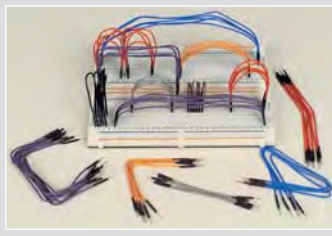

**MICRO-LEADS
NOT SUPPLIED
SEE PAGE 206**

Logic test unit



AT104 is a test bed intended for learning about logic circuits. Several of the commonest circuits are integrated into the test bed. They are fed and their inputs/outputs are clearly indicated on short summaries. There are: 3 inverters - 3 exclusive OR - 6 AND - 6 OR - 6 NAND - 6 NOR.

A manual supplied with the test bed shows how to make: an RS, D bistable, a comparison unit, a trigger, a counter etc.

Maintenance: the cover is removable, the standard circuits are easily replaced.

Dimensions: 340 x 265 x 130mm Weight 4.7kg. Mains 230V.

1 INTERCONNECTION BREADBOARD with 1580 contacts, 2 fields of 640 contacts bearing the components, 3 fields of 100 feed distribution contacts

4 SUPPLIES immediately next to the board, short circuit protected.

SUPPLY	+5V/1A	0 to +15V/0,5A	0 to -15V/0,5A	-5V/0,5A	
REGULATION	<100mV <50mV	<150mV <150mV	<150mV <150mV	<30mV <25mV	Load variation 100% Mains variation 15%

3 CLOCKS at fixed frequencies of 1Hz - 10Hz - 100Hz square signal 0 to 5V
Short circuit protected.

1 SHORT CIRCUIT INDICATOR lights up when a supply or clock has short circuited.

4 SWITCHES delivering between 0 and +5V.

8 LED DISPLAYS marked 0 to 7

ref. AT104

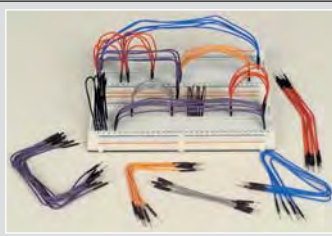

**MICRO-LEADS
NOT SUPPLIED
SEE PAGE 206**

Electronic test unit



ref. AT102

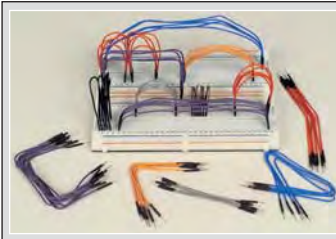

**MICRO-LEADS
NOT SUPPLIED
SEE PAGE 206**

ELEMENT OF REPLACEMENT

The central board.
Identical for the 3 benches (AT102 - AT104 - AT106).
For receptacle 173 x 120mm.

ref. PR6

Designed for installation and rapid testing of prototypes and for practical experiments with analog and digital circuits. The contact board, which is hardwearing, is removable.
Dimensions: 340 x 265 x 130mm. Weight: 4.8kg.

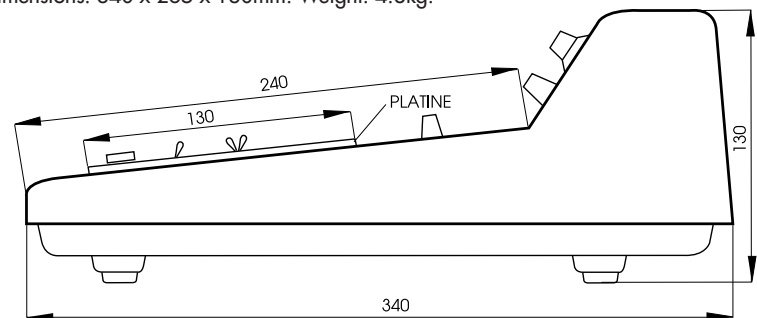

The components are inserted on the contact board with the normal pitch spacing of 2.54mm. There are 1896 contact points divided into:
12 contact points of supply lines
256 separate sets of 5 contact points receiving components and interconnections.

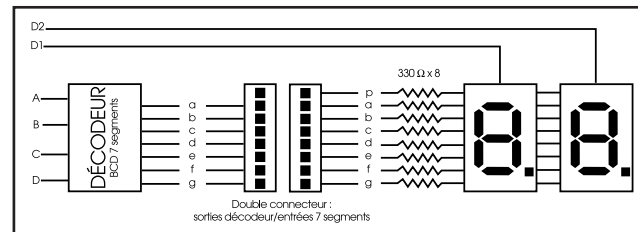

4 SUPPLIES

Positioned in view immediately on the face, they are protected against short circuits

- Variable DC from 0 to +15V 300mA (ripple 30mV)
- Variable DC from 0 to -15V 300mA (ripple 30mV)
- Fixed DC +5V, 1A (100mV ripple)
- Fixed DC -5V, 100mA (30mV ripple)

1 FUNCTION GENERATOR

From 0.1Hz to 200kHz in 6 ranges varied with a control dial. The output is protected against short circuits.

- Sinewave, level variable from 0 to 10V peak-to-peak
- Triangular wave, level variable from 0 to 5V peak-to-peak
- Square wave, level variable from 0 to 15V peak-to-peak

2 DIGITAL DISPLAYS

7 segments and decimal point display. Switched by the inputs of D1 & D2.

- Direct control of each segment, a b c d e f
- Access to the input of the ABCD decoder IC

1 DC DIGITAL VOLTMETER

3 1/2 digits with a maximum reading of 2,000.
Ranges 200mV-2-20-200VDC. Input impedance 10MΩ

1 UNIVERSAL COUNTER 8 DIGITS

Frequencymeter 1 Hz to 100MHz. Periodmeter 99,999 999μs.
TTL & CMOS Internal/External Input

8 DIODE DISPLAY

Status from 0 to 7 with lamps to view logic levels.

10 LOGIC SWITCHES

- 8 with 2 positions giving a voltage a either 0 or 5V
- 2 with 3 positions giving voltages of -5V 0V +5V

2 LOGIC PUSHBUTTONS

2 anti-bounce outputs A and \bar{A} (respectively B and \bar{B}) supplying a level between 0 and 5V on the side of the unit.

4 ADAPTERS

These adapters allow the unit to be connected to an external electronic unit.

- 2 banana inputs of 4mm diameter
- 2 inputs of female BNC connectors

TEST UNITS

Electronic test boards

Contact boards for the design and rapid testing of circuits. The double reed contacts of these boards are in nickel plated bronze. They are pitched 1 inch/2.54 mm apart in an insulating ABS base. Contacts grouped in strips of 5 or 10, can be fully dismantled from the rear. Use components or leads with maximum diameter 0.6mm.



REF. PAL2420



REF. GL12



REF. GL48

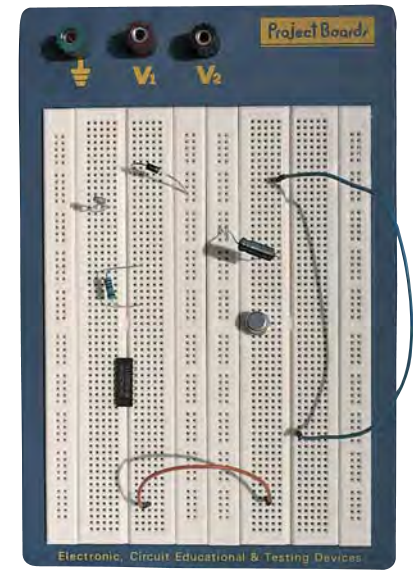

REF. GL24

Model with integrated power supply protected from short-circuits (PAL2420): 0 to +1.5V/500mA continuously variable ; 0 to -1.5V/500mA continuously variable ; +5V/1A fixed

Ref.	PAL2420	PAL2420S*	GL12	GL12S*	GL24	GL24S*	GL48	GL48S*
Nb of contacts	2420	2420	840	840	1680	1680	3260	3260
Dimensions mm	245 x 195	245 x 195	200 x 75	200 x 75	225 x 150	2250 x 150	260 x 240	260 x 240

* With safety sockets

Micro-leads

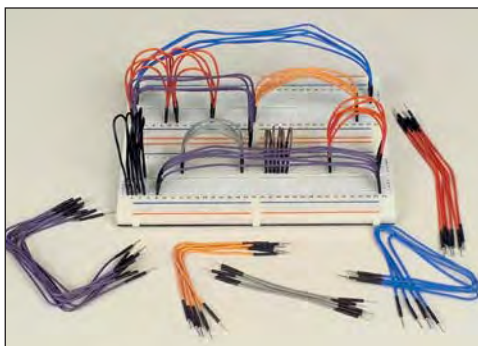

Storage box for micro-leads

8 racks. Transparent plastic cover.
Total capacity of the box:
160 micro-leads.
Dimensions : 230 x 160 x 30mm.
Weight : 180g

ref. MICRO-B



Interface lead

Special lead to connect the testing boards and any system in diameter 2mm.
Max current 500mA.

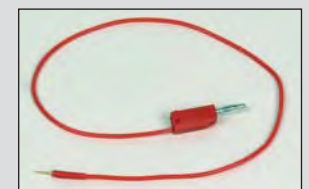

ref. INTER-2R
25cm Red color

ref. INTER-2N
25cm Black color

Ref.	M5	G7	O1	R10	N10	V1	B2
Length	50 mm	70 mm	100 mm	100 mm	100 mm	150 mm	200 mm
Color obligatory	BROWN	GREY	ORANGE	RED	BLACK	PURPLE	BLUE

The flexible wire used for these leads is terminated at each end by a 0.6mm diameter nickel-plated plug. The electrical contact is excellent.

Temperature sensors and heating control

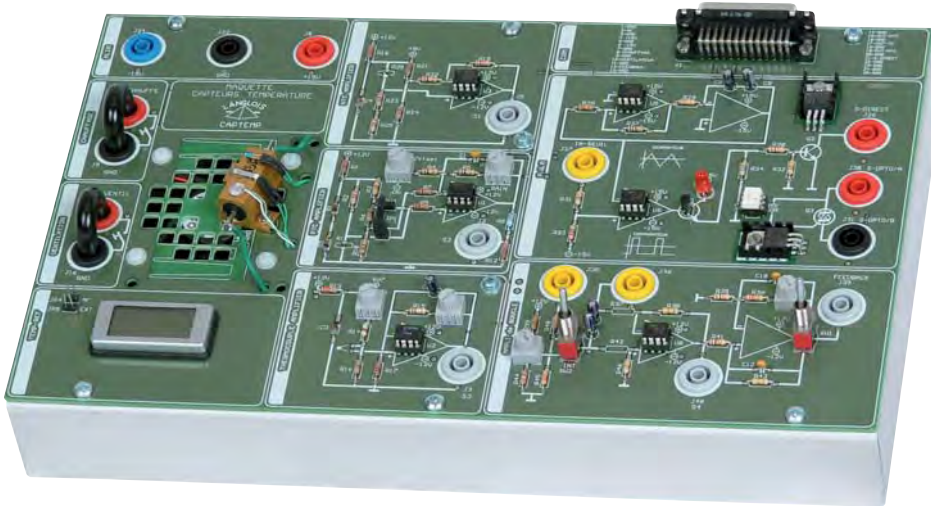

ref. CAPTEMP

EDUCATIONAL OBJECTIVES

- Studying the regulation of temperature all or nothing
- Studying the regulation of temperature with control loop with variable gain
- Studying of thermal sensors: thermocouple, thermistor NTC and PTC.

USER'S MANUAL + PRACTICAL WORKS

Proposed Practical Works

- Studying and calibration of a conditioner temperature sensor
 - Studying the gain of the amplifier sensor PTC100
 - Studying of the offset of the amplifier
 - Gain calibration by a standard 22 ohm resistor
 - Adjusting the offset of the amplifier
 - Thermocouple calibration
- Features of temperature transducers
- Control of the temperature by hysteresis
- Control of the temperature by feedback

This model includes 3 temperature sensors: NTC thermistor – J thermocouple – PT100 platinum probe. These sensors are attached to a resistance or cooled by a built-in fan. The resistance and fan are controlled separately by short circuiting two terminals. The screen-printed front panel shows actual cabling of electronic circuits such as amplifiers and automated temperature control.... All the components are surface-mounted to facilitate signal capture.

Each of the three analog sensors is connected to an amplifier to suit its voltage, impedance, and linearity. The output levels of the three amplifiers are all calibrated at 10mV/°C to facilitate comparisons of accuracy and thermal inertia.

Two temperature control systems may be studied: all or nothing heating by hysteresis circuit or proportional heating with a variable gain automatic control loop. The heating " power " circuit is either powered by transistor-controlled direct current or by Triac-controlled 15VAC alternating current. A digital thermometer provides a continuous readout of heating element temperature.

CHARACTERISTICS

- +15V / -15V DC power supply
- Equipped with a DB25 male plug to connect to the PC interface.
- Dimensions : 330 x 200 x 50mm
- Weight : 1kg

DATA ACQUISITION SOFTWARE (OPTION)

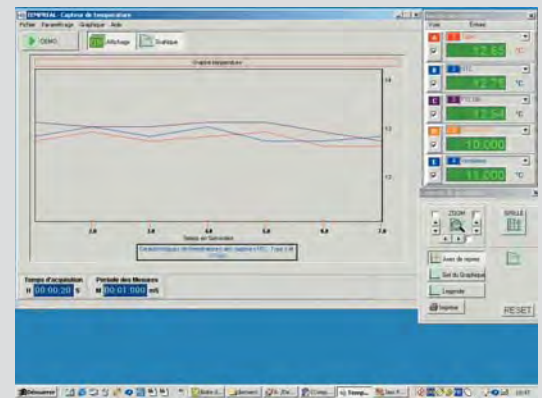
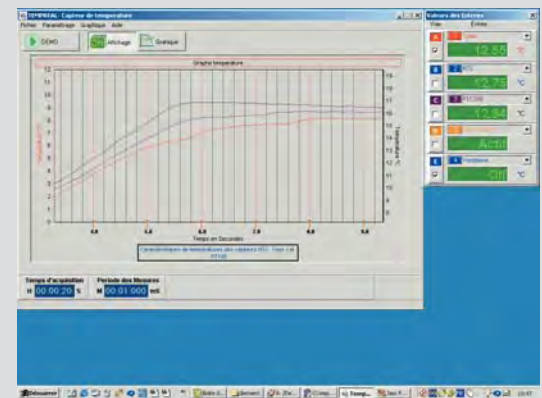

ref. LOG-CAPTEMP

This option consists of an interface unit, a connecting cable, and software.

This software records the temperature readouts for the PT100, NTC, and J sensors on the SENSOR model and displays them on the computer screen. Characteristics such as the "all or nothing" setting for heating and fan power supply may also be displayed on the screen.

CHARACTERISTICS

- On-screen temperature display for the 3 sensors.
- On-screen display of the fan and heating control signal characteristics.
- Configurable acquisition time.
- Zoom function.
- Cursor function x and y axes configurable
- (Scale, notation, Max and Min values)
- Curve and background colours configurable.
- Print characteristics after page layout configuration.
- Acquisition data recovery in spreadsheet form

SOFTWARE AVAILABLE IN ENGLISH AND IN FRENCH

Speed feedback

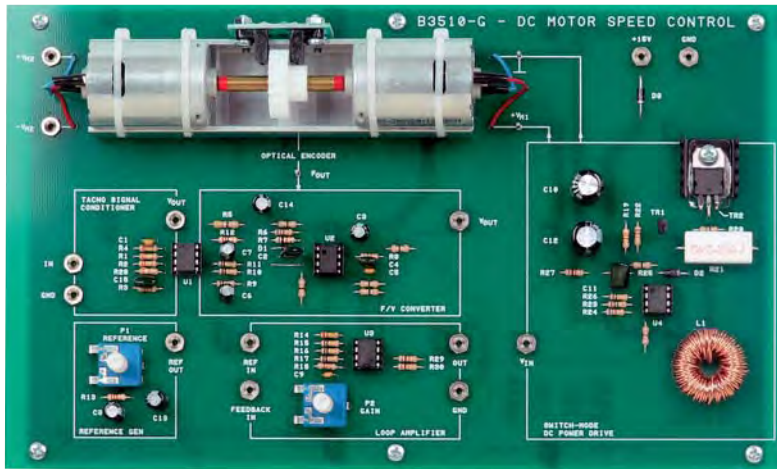

This model is designed for the simplified study of a speed feedback on a closed loop, with a feedback signal generated either by a tachometric dynamo, or by an optical impulsion encoder. It consists of a direct current motor which drives a second direct current motor, functioning as a generator. The signal issuing from this generator is used as an image of the speed. The shaft assembly also drives a toothed disc, which cuts a luminous barrier, the impulses of which are applied to a frequency voltage converter. A direct current adjustable source integrated in the model is used as the voltage reference level. A switching supply controlled by the error voltage supply the motor.

ACCESSORIES SUPPLIED

1 set of leads Ø2mm : 2 x 100cm / 2 x 30cm / 2 x 15cm

ref. B3510-G

Dim. : 250 x 150 x 30mm. Weight : 900g.

All or nothing sensors and actuators

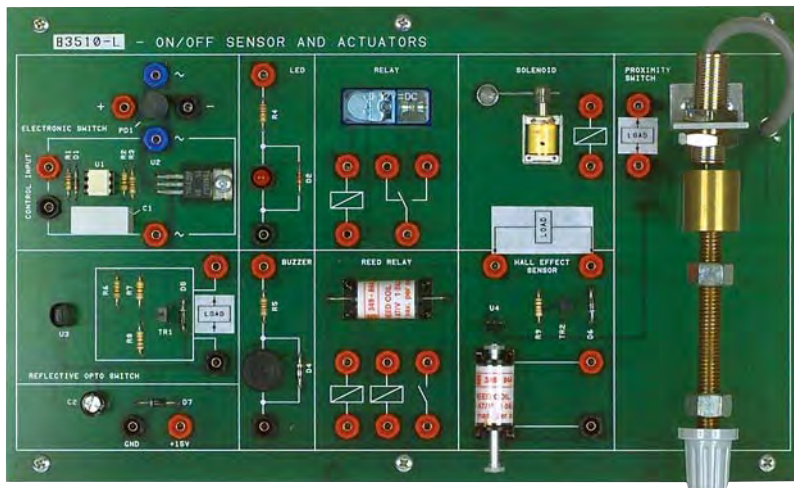

This model includes sensors currently used in industry:

- an optoelectro-reflection barrier, with its output amplifier
- a Hall effect sensor with its output amplifier
- an inductive proximity sensor with its output amplifier
- facing a metallic mass which the operator progressively displaces using a worm screw.

The model also includes:

- an electronic switch consisting of a triac and its electronic control
- a dry relay and a reed relay with two coils
- two solenoids
- one facing the Hall sensor
- a visual LED display and a piezoceramic type buzzer with integral micro-oscillator.

ref. B3510-L

Dim. : 250 x 150 x 30mm. Weight : 900g.

Stepping motor

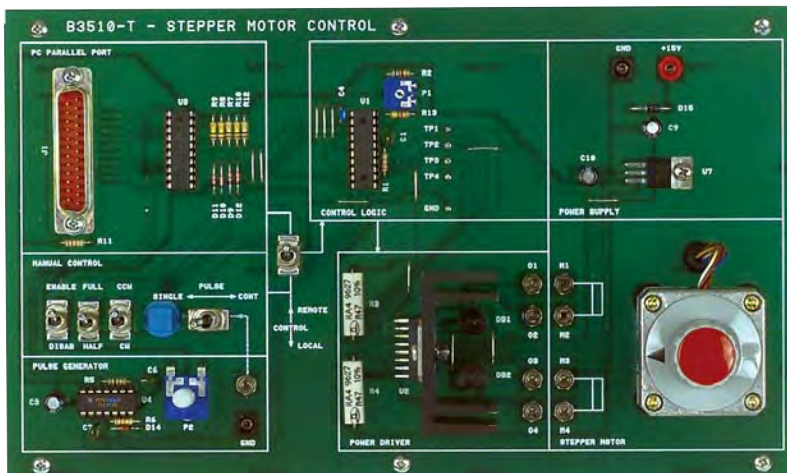

Includes a stepping motor with 2 separate coils, the motor driver and the specialised logic test circuit. The latter can be accessed either by a PC via a 25 pin parallel port, or by a manual control logic system integrated. This logic comprises a controled impulse generator by push button for the step by step lead and a variable frequency generator for the continuous working.

ACCESSORIES SUPPLIED

1 set of leads Ø2mm : 2 x 100cm / 4 x 30cm / 3 x 15cm

1 lead DB25 SERIE

1 software on CD

ref. B3510-T

Dim. : 250 x 150 x 30mm. Weight : 900g.

SOFTWARE SUPPLIED

PRACTICAL WORKS

- Study of the luminous barrier/frequency voltage converter.
- Study of the tachometric filter.
- Study of the loop amplifier and of the controlled switching power supply.
- Comparison of tachometric voltages and optical encoder + converter.
- Comparison of low rotation frequencies with and without feedback loop.
- Study of the feedback response for different values of loop gain.

PRACTICAL WORKS

- Description of the different components and their usage.
- Functioning of the amplifiers.
- Measurement of the detection distance of the inductive sensor.
- Analysis of the electronic switch, controlled by direct or alternating current.
- Study of a line consisting of an optoelectro-barrier, a switch and a solenoid.
- Possibility of making other lines: optoelectro-barrier - reed relay - Hall sensor - electronic switch - buzzer

ACCESSORIES SUPPLIED

1 set of leads Ø2mm :
2 x 100cm / 2 x 50cm / 3 x 30cm / 3 x 15cm

PRACTICAL WORKS

- Study of the principle of a stepping motor and its different ways of functioning by step and half-step.
- Vibrations seen at low frequency, loss of steps at high frequency.
- Determination of the take-in resonance frequency and of the rotation limit frequency
- Observation of signals delivered by the driver to the motor windings.
- Inversion of currents in the motor coils.
- Observation of 4 signals applied by the control logic to the driver out of phase with one another.

PRACTICAL WORK WITH COMPUTER

A program in basic and working in DOS is supplied. This completely listed program can be freely copied and if necessary modified by the user. In particular, it allows control of the speed and direction of rotation.

Position feedback

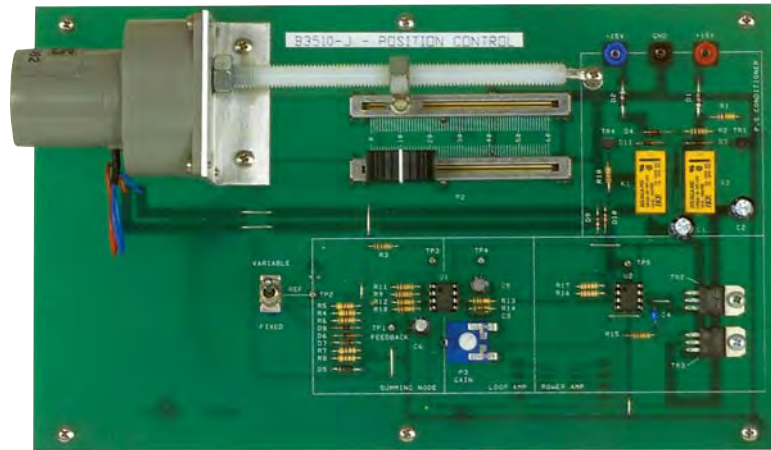
ref. B3510-J

This model is designed for the simplified study of a closed position feedback loop. It is composed of a direct current motor, the rotation of which drives a worm-screw.

The screw cursor is integrally attached to a copying potentiometer which supplies an electrical image of its position.

The potentiometer operated manually determines the basic position.

PRACTICAL WORKS

- Study of the principle of a closed feedback loop: error voltage, pre-amplification, driver stage, push-pull.
- Study of limitation of movements circuits.
- Anti-jamming system.
- Study of the feedback response to a voltage step for different values of loop gain.

ACCESSORIES SUPPLIED

1 set of leads Ø2mm : 3 x 100cm / 2 x 30cm

Incremental & absolute encoder

ref. B3510-R

This model illustrates how an incremental encoder and an absolute encoder work. They work in exactly the same way as commercial encoders. However, since resolution is not important in our application, the number of sensors is limited to 5. The model has two interchangeable encoder discs, with the sectors representing DCB encoding and Gray encoding.

When the operator turns the disc by hand, the phototransistors underneath send their signals to the decoding logic and the display (4 line x 20 character LCD screen) and to 4mm-diameter terminals, in order to control all of the control or decoding logics performed by the operator. The sensitivity of the phototransistors can be adjusted depending on the ambient light.

PRACTICAL WORKS

- 3-BIT ABSOLUTE DCB ENCODER correspondence between the position of the disc, the status of the sensors and the display. Transition codes and synchronisation sensor.
- INCREMENTAL DCB ENCODER use of the encoder in counter and count-down mode. Detection of the direction of rotation, improvement of accuracy using an angle sensor.
- 4 BIT GRAY ENCODER GRAY/DCB code comparison. A synchro. sensor is required.